

SPECIFICATIONS, PROPOSAL AND CONTRACT DOCUMENTS

FOR

STREET IMPROVEMENTS

**ANGEL STREET, PARKER STREET, VINE STREET, BRYANT STREET, &
4TH AVENUE (FROM CEDAR STREET TO THE TOWN LIMITS)**

REBUILD ALABAMA ACT (RAA) ANNUAL GRANT PROGRAM

PREPARED FOR:

TOWN OF BEATRICE

JULY 2020



SOUTHERN
ENGINEERING SOLUTIONS

Andalusia, Alabama

SPECIFICATIONS

PROPOSAL AND CONTRACT DOCUMENTS

STREET IMPROVEMENTS

**ANGEL STREET, PARKER STREET, VINE STREET, BRYAND STREET, & 4TH AVENUE
(FROM CEDAR STREET TO THE TOWN LIMITS)
REBUILD ALABAMA ACT (RAA) ANNUAL GRANT PROGRAM**

**TOWN OF BEATRICE
BEATRICE, ALABAMA**

July, 2020

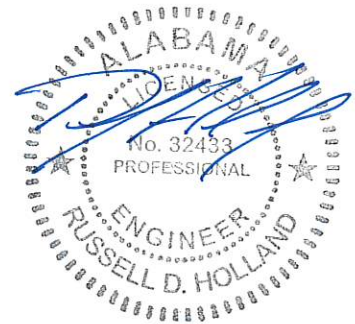

Prepared by:

**SOUTHERN ENGINEERING SOLUTIONS, INC.
201 EAST TROY STREET
P.O. BOX 610
ANDALUSIA, ALABAMA 36420
(334) 222-1849**

TABLE OF CONTENTS

	PAGE
ADVERTISEMENT FOR BIDS.....	1
INFORMATION FOR BIDDERS	2
BID BOND	6
PROPOSAL	8
AGREEMENT.....	12
PAYMENT BOND.....	15
PERFORMANCE BOND	17
NOTICE OF AWARD	19
NOTICE TO PROCEED	20
CHANGE ORDER	21
CERTIFICATION BY OWNER.....	22
GENERAL CONDITIONS.....	23
SUPPLEMENTAL GENERAL CONDITIONS.....	37
SPECIAL SPECIFICATIONS	42

ADVERTISEMENT FOR BIDS

Sealed bids for the construction of **Street Improvements – Angel Street, Parker Street, Vine Street, Bryant Street, & 4th Avenue (From Cedar Street To The Town Limits), Rebuild Alabama Act (RAA) Annual Grant Program** in Beatrice, Alabama will be received by the **Town of Beatrice** in the meeting room at the Town Hall until **10:00 a.m., Tuesday, August 25, 2020**, and then at said location publicly opened and read aloud.

The work under the Base Bid generally consists of

424A Concrete Wearing Surface	1,075 Tons
424A Leveling and Patching	450 Tons
424B Concrete Binder Layer	190 Tons

The information for Bidders, Form of Bid, Form of Contract, Plans, Specifications, and form of Bid Bond, Performance and Payment Bond, and other Contract Documents may be examined at the Beatrice Town Hall; 1112 Main Street; Beatrice, Alabama 36425 and at the office of Southern Engineering Solutions, Inc., 201 East Troy Street, Andalusia, Alabama, 36420.

To be eligible for consideration, bids must be submitted on complete proposals made available by the Owner. Complete digital project bidding documents are available upon an online payment of a non-refundable fee of \$40.00 by visiting our website - www.southernengineeringsolutions.com and clicking the “Currently Bidding” link at the top of the page. A free one-time membership registration with Quest CDN will be required. Please contact questcdn.com at 952-233-1632 or info@questcdn.com if you require assistance in registration, downloading, or working with this digital project information. Optional complete paper bid documents are available at Southern Engineering Solutions, Inc.; P O Box 610; 201 East Troy Street; Andalusia, Alabama 36420, upon payment of a refundable (if plans are returned in reusable condition within 10 days of bid opening) deposit of \$80.00. Bid documents will be mailed only upon receipt of deposit. If paper option is chosen, checks shall be made payable to Southern Engineering Solutions, Inc. No paper bid documents will be distributed later than 48 hours prior to the scheduled opening of bids. The Owner reserves the right to reject any or all bids and to waive any informalities.

Each bidder must submit with his bid, security in the amount, form, and subject to the conditions provided in the Information for Bidders. The successful bidder will be required to submit a 100% performance bond and a 50% payment bond.

All bidders must comply with the requirements of the Contractor's Licensing Law of the State of Alabama and be certified for the type of work for which a proposal is submitted. The submission of the Bidders' current State of Alabama license number will be required before his/her bid will be received or considered.

No bidder may withdraw his bid within 30 days after the actual date of the opening thereof.

Annie M. Shelton
Mayor
Town of Beatrice

INFORMATION FOR BIDDERS

Bids will be received by the **Town of Beatrice, Alabama** (herein called the Owner) at **Beatrice Town Hall, 1112 Main Street; Beatrice, Alabama 36425** until **10:00 a.m., Tuesday, August 25, 2020**, and then at said location publicly opened and read aloud.

Delivery of Proposal. Each bid must be submitted in a sealed envelope, addressed to the **Town of Beatrice; P O Box 56; 1112 Main Street; Beatrice, Alabama 36425.**

Each sealed envelope containing a bid must be plainly marked on the outside as "**Bid for Street Improvements – Angel Street, Parker Street, Vine Street, Bryant Street, & 4th Avenue (From Cedar Street To The Town Limits)**" and the envelope should bear on the outside the name of the Bidder, his address, his license number and the name of the project for which the bid is submitted. If forwarded by mail, the sealed envelope containing the bid must be enclosed in another envelope addressed to the **Town of Beatrice; P O Box 56; 1112 Main Street; Beatrice, Alabama 36425.**

Preparation of Bid Form. All bids must be made on the required bid form. All blank spaces for bid prices must be filled in, in ink or typewritten, and the bid form must be fully completed and executed when submitted. Only one copy of the bid form is required.

Withdrawal of Bids. Any bid may be withdrawn prior to the above scheduled time for the opening of the bids or authorized postponement thereof, provided a request in writing executed by the Bidder or his duly authorized representative is filed with the Owner prior to that time. Upon receipt and confirmation of such notice, the unopened bid will be promptly returned. Except as provided in the foregoing, no bid may be withdrawn.

General. The Owner may waive any informalities or minor defects or reject any and all bids. Any bid received after the time and date specified shall not be considered. Except for the condition described below, no Bidder may withdraw a bid within 30 days after the actual date of the opening thereof. Should there be reasons why the contract cannot be awarded within the specified period, the time may be extended by mutual agreement between the Owner and the Bidder.

Mistakes. The low bidder may seek withdrawal of his bid without forfeiture by providing written notice to the Owner within three working days after the date of the bid opening by providing convincing evidence he made a mistake in his bid caused by calculation or clerical error, an inadvertent omission, or a typographical error which causing his bid to be substantially out of proportion to that of other bidders. The Owner will make a decision within 10 days of receipt of the bidder's notice, or by the next regular meeting of the awarding authority. In no event, shall a mistake of law, judgement, or opinion constitute valid grounds for withdrawal of a bid without forfeiture. Upon withdrawal of bid without forfeiture, the low bidder who withdraws his bid due to a mistake shall not be allowed to participate in any work on the contract in any capacity, and shall not be allowed to participate in a rebid of the project.

A conditional or qualified Bid will not be accepted.

Award will be made to the lowest responsible Bidder.

Interpretation of the Quantities in Bid Schedule. Bidders must satisfy themselves of the accuracy of the estimated quantities in the Bid Schedule by examination of the site of the proposed work and a review of the drawings and specifications, including Addenda. After bids have been submitted, the Bidder shall not assert that there was a misunderstanding concerning the quantities of work or of the nature of the work to be done. Although the estimate of quantities of work listed in the Bid Schedule are the results of calculations made from field survey, they are to be considered as only approximate estimates of the quantities of the different pay items and are to be used only as a basis for comparing bids for awarding the contract. Payment to the Contractor will be made only for the actual quantities of work performed in accordance with the plans and specifications. If, upon completion of construction, the actual quantities of work performed under unit price bids shall show either increase or decrease from the quantities shown in the Bid Schedule, the unit prices bid will prevail, except as otherwise provided for herein.

The right is reserved to increase or decrease any or all of the amounts given in the approximate quantities as shown in the Bid Schedule, with the understanding that the work to be done and the materials to be furnished under unit price bids may be increased or decreased not exceeding twenty-five percent (25%) of the total money value of the contract without in any way invalidating the bid prices.

Examination of Specifications, Special Provisions and Site of Work. All Bidders are required to examine carefully the site of the proposed work, the Bid Form, Plans, Standard Specifications, Supplemental Specifications, Special Provisions, Agreement Form and Bond Forms. The submission of a Bid Form shall be prima facie evidence that the Bidder has made such examination and has judged for and satisfied himself as to the conditions to be encountered; as to the character quality and quantities of work to be performed and materials to be furnished; as to the requirements of Plans, Specifications, Supplemental Specifications, Special Provisions, Agreement and Bonds; and as to the contingencies. No adjustments or compensation will be allowed for losses caused by failure to comply with the above requirements.

Familiarity with Laws and Ordinances. All applicable laws, ordinances, and the rules and regulations of all authorities having jurisdiction over construction of the Project shall apply to the contract throughout. Bidders shall familiarize themselves with all such applicable laws, ordinances and regulations, and comply with their requirements which may directly or indirectly affect the work or its prosecution, and any materials or equipment used in the work. No adjustments or compensation will be allowed for losses caused by failure to comply with the above requirements.

Details. The Bidder must specify for both dollars and cents (without interlineation, alterations or erasures, unless initialed by the signer of the proposal) a unit price for each of the separate items for which a quantity is given in the proposal form (except when alternate bids are called for on items) and shall show the products of the respective unit prices and the estimated quantities in the columns provided for that purpose except that any item noted for a "Lump Sum" bid shall have the same amount under the column provided in the proposal for "Unit Price" as that written numerically in the "Amount Bid" column. All figures shall be inked or typed. The Owner will check the extension of each item given in the proposal and correct all errors or discrepancies. The gross

sum obtained by adding all of the products of the unit prices and the various estimated quantities listed in the proposal with the lump sum items shall prevail and this shall be the contract bid price. Signing. The Bidder's proposal must be signed in ink by the individual, by one or more members of the partnership, or by one or more offices of a corporation, or by an agent of the Contractor legally qualified and acceptable to the Owner. If the proposal is made by an individual, his name and post office address must be shown; by a corporation, the name of the corporation and the business address of its corporate officials must be shown. The proposal Bid Bond shall be properly signed by the Bidder and the surety.

Irregular Proposal. Proposals will be considered irregular and may be rejected if they contain any omissions, alterations of form, additions not called for, alternate bids unless called for, incomplete bids, erasures or alterations not initialed by the person signing the proposal, or other irregularities of any kind.

Information. The Owner shall provide to Bidders prior to Bidding, all information which is pertinent to, and delineates and describes, the land owned and rights-of-way acquired or to be acquired.

Contract Documents. The Contract Documents contain the provisions required for the construction of the Project. Information obtained from an officer, agent, or employee of the Owner or any other person shall not affect the risks or obligations assumed by the Contractor or relieve him from fulfilling any of the conditions of the contract.

Bond Requirements. Each Bid must be accompanied by a Bid Bond payable to the Owner for five percent of the total amount of the Bid not to exceed \$10,000.00. As soon as the Bid prices have been compared, the Owner will return the Bonds of all except the three lowest responsible Bidders. When the Agreement is executed, the Bonds of the two remaining unsuccessful Bidders will be returned. The Bid Bond of the successful Bidder will be retained until the Payment Bond and Performance Bond have been executed and approved, after which it will be returned. A certified check may be used in lieu of a Bid Bond.

A Performance Bond in the amount of 100 percent of the Contract price, with a corporate surety approved by the Owner, will be required for the faithful performance of the contract.

A Payment Bond in the amount of 50 percent of the Contract price, with a corporate surety approved by the Owner, will be required to guarantee the payment by the Contractor of all costs of labor, materials, equipment, subcontractors, etc. necessary to complete the work in accordance with the Contract.

Attorneys-in-fact who sign Bid Bonds or Payment Bonds and Performance Bonds must file with each Bond a certified and effective dated copy of their power of attorney.

Execution of Agreement. The party to whom the contract is awarded will be required to execute the Agreement and obtain the Performance Bond and Payment Bond within fifteen (15) calendar days from the date when Notice of Award is delivered to the Bidder. The Notice of Award shall be accompanied by the necessary Agreement and Bond forms. In case of failure of the Bidder to execute the Agreement, the Owner may at his option consider the Bidder in default, in which case

the Bid Bond accompanying the proposal shall become the property of the Owner to be processed in accordance with prevailing law.

The Owner within twenty (20) days of receipt of acceptable Performance Bond, Payment Bond and Agreement signed by the party to whom the Agreement was awarded shall sign the Agreement and return to such party an executed duplicate of the Agreement. Should the Owner not execute the Agreement within such period, the Bidder may by Written Notice withdraw his signed Agreement. Such notice of withdrawal shall be effective upon receipt of the notice by the Owner.

Notice to Proceed. The Notice to Proceed shall be issued within fifteen (15) days of the execution of the Agreement by the Owner. Should there be reasons why the Notice to Proceed cannot be issued within such period, the time may be extended by mutual agreement between the Owner and the Contractor. If the Notice to Proceed has not been issued within the fifteen (15) day period or within the period mutually agreed upon, the Contractor may terminate the Agreement without further liability on the part of either party.

Qualifications of Bidders. The Owner may make such investigations as he deems necessary to determine the ability of the Bidder to perform the work, and the Bidder shall furnish to the Owner all such information and data for this purpose as the Owner may request. The Owner reserves the right to reject any Bid if the evidence submitted by, or investigation of, such Bidder fails to satisfy the Owner that such Bidder is properly qualified to carry out the obligations of the Agreement and to complete the Work contemplated therein.

Responsibilities of Bidders. Each Bidder is responsible for inspecting the site and for reading and being thoroughly familiar with the Contract Documents. The failure or omission of any

Bidder to do any of the foregoing shall in no way relieve any Bidder from any obligation in respect to this Bid.

The low Bidder shall supply the names and addresses of major material Suppliers, and Subcontractors when requested to do so by the Owner.

Engineer. The Engineer is Southern Engineering Solutions, Inc., P. O. Box 610 (201 East Troy Street), Andalusia, Alabama 36420.

BID BOND

KNOW ALL MEN BY THESE PRESENTS, that we, the undersigned, _____
_____ as Principal, and
_____ as Surety, are hereby
held and firmly bound unto the **Town of Beatrice** as OWNER in the penal sum of
_____ for the payment of which, well and
truly to be made, we hereby jointly and severally bind ourselves, successors and assigns. Signed,
this _____ day of _____, 2020.

The Condition of the above obligation is such that whereas the Principal has submitted to
the **Town of Beatrice** a certain BID, attached hereto and hereby made a part hereof to enter into a
contract in writing, for the

**STREET IMPROVEMENTS
ANGEL STREET, PARKER STREET, VINE STREET, BRYANT STREET, & 4TH AVENUE (FROM CEDAR
STREET TO THE TOWN LIMITS)**

NOW THEREFORE,

- (a) If said BID shall be rejected, or
- (b) If said BID shall be accepted and the Principal shall execute and deliver a contract in
the Form of Contract attached hereto (properly completed in accordance with said
BID) and shall furnish a BOND for his faithful performance of said contract, and for
the payment of all persons performing labor or furnishing materials in connection
herewith, and shall in all other respects perform the agreement created by the
acceptance of said BID,

then this obligation shall be void, otherwise the same shall remain in force and effect; it being
expressly understood and agreed that the liability of the Surety for any and all claims hereunder
shall, in no event, exceed the penal amount of this obligation as herein stated.

The Surety, for value received, hereby stipulates and agrees that the obligations of said Surety and its BOND shall be in no way impaired or affected by any extension of the time within which the OWNER may accept such BID; and said Surety does hereby waive notice of any such extension.

IN WITNESS WHEREOF, the Principal and the Surety have hereunto set their hands and seals, and such of them as are corporations have caused their corporate seals to be hereto affixed and these presents to be signed by their proper officers, the day and year first set forth above.

Principal (L.S.)

Surety

By: _____

IMPORTANT -- Surety companies executing BONDS must appear on the Treasury Department's most current list (Circular 570 as amended) and be authorized to transact business in the state where the project is located.

Proposal for the Construction of
STREET IMPROVEMENTS
ANGEL STREET, PARKER STREET, VINE STREET, BRYANT STREET, & 4TH AVENUE (FROM CEDAR STREET TO THE TOWN LIMITS)
For
TOWN OF BEATRICE

Date: _____

Proposal of _____
(Legal Name of Bidder)

Of _____
(Mailing Address of Bidder)

License No _____, for the construction of **STREET IMPROVEMENTS – ANGEL STREET, PARKER STREET, VINE STREET, BRYANT STREET, & 4TH AVENUE (FROM CEDAR STREET TO THE TOWN LIMITS)**

To the **TOWN OF BEATRICE**, hereinafter referred to as the Owner:

The following proposal is made in behalf of the undersigned Bidder and no others. Evidence of authority to submit the proposal is herewith furnished. The proposal is made without collusion on the part of any other person, firm or corporation.

The undersigned Bidder certifies that he has carefully examined the Plans for this project and Specifications attached, including the Special Provisions, and has personally examined the site of the work. On the basis of the Specifications and Plans, the undersigned Bidder proposes to furnish all necessary machinery, tools, apparatus, and other means of construction, and do all the work and furnish all the material in the manner specified.

The undersigned Bidder agrees to commence work under this contract on or before a date to be specified in a written Notice to Proceed issued by the Owner and to fully complete the project within **thirty (30)** calendar days thereafter.

The undersigned Bidder understands that the quantities below are approximate only and are subject to either increase or decrease and hereby proposes to perform any increase or decrease in quantities of work at the unit price bid.

The undersigned Bidder agrees to perform all "Force Account or Extra Work" that may be required of him on the basis provided in the specifications attached, and to give such work his personal attention in order to see that it is economically performed.

The undersigned Bidder also proposes to furnish a Performance Bond, in an amount equal to the total amount of his bid. This bond shall serve not only to guarantee the completion of the work on the part of the undersigned Bidder, but also to guarantee the excellence of both workmanship and materials until the work is finally accepted.

The undersigned Bidder encloses a Certified Check or Bid Bond in the amount of 5% of amount bid, not to exceed \$10,000.00 and hereby agrees that in case of his failure to execute a contract and furnish the required bond within 5 days after Notice of Award, the amount of the check or Bid bond will be forfeited to the owner as liquidated damages arising out of his failure to execute a contract as proposed. It is understood that in case the work is not awarded to the undersigned Bidder, the check or Bid bond will be returned as provided in the Specifications hereto attached.

The undersigned Bidder agrees to pay to the Owner as liquidated damages the amount of **\$500.00** per calendar day for any overrun in contract time for which a time extension is not granted by the Owner, as provided in Section 5 of the Supplemental General Conditions.

The undersigned Bidder acknowledges receipt of the following Addenda:

No. _____, Dated _____.

No. _____, Dated _____.

No. _____, Dated _____.

No. _____, Dated _____.

The Bidder agrees that this bid shall be good and may not be withdrawn for a period of 30 calendar days after the scheduled closing time for receiving bids, except as approved by the Owner.

The Bidder understands that the Owner reserves the right to reject any or all bids and to waive any informalities in the bidding.

The following unit prices shall include all labor, materials, overhead, profit, insurance, etc., to cover the finished work of the several kinds called for.

The undersigned Bidder agrees to perform all the work described in the Contract Documents for the following unit prices:

PROPOSAL
STREET IMPROVEMENTS
TOWN OF BEATRICE, ALABAMA

BASE BID					
LINE NO.	DESCRIPTION	QUANTITY & UNIT		UNIT PRICE	AMOUNT BID
1	Mobilization	1	LS	\$	\$
2	Tack Coat	1220	GAL	\$	\$
3	Superpave Bituminous Concrete Wearing Surface Layer , 1/2" Maximum Aggregate Size Mix, ESAL Range A/B (135 lb/sy and 165lb/sy)	1075	TON	\$	\$
4	Superpave Bituminous Concrete Upper Binder Layer , 1/2" Maximum Aggregate Size Mix, ESAL Range, C/D (165 lb/sy)	190	TON	\$	\$
5	Superpave Bituminous Concrete Layer, Leveling , 3/8" Maximum Aggregate Size Mix, ESAL Range A/B (As Needed)	280	TON	\$	\$
6	Superpave Bituminous Concrete Layer, Patching , 1/2" Maximum Aggregate Size Mix, ESAL Range A/B	170	TON	\$	\$
7	Prime Coat (4th Avenue)	210	GAL	\$	\$
8	Roadbed Processing	8	RBST	\$	\$
9	Joint Sealant for Hot Mix Asphalt	1.31	MILE	\$	\$
10	Temporary Traffic Control Markings	198	SF	\$	\$
11	Traffic Control Markings, Class 2, Type A	198	SF	\$	\$
12	Traffic Control	1	LS	\$	\$
13	Materials Testing - CASH ALLOWANCE	1	LS	\$ 4,500.00	\$ 4,500.00
TOTAL BASE BID					\$

Signature of Bidder (if a firm or individual) _____

By _____

Address of Bidder _____

Names and addresses of members of firm _____

Signature of Bidder (if a corporation) _____

President Address

Secretary Address

Treasurer Address

Corporate Seal

Name of state under the law of
which the corporation is chartered:

Attest: _____
Secretary

AGREEMENT

THIS AGREEMENT, made this ____ day of _____, 2020, by and between the **Town of Beatrice**, hereinafter called "OWNER" and _____ doing business as a corporation hereinafter called "CONTRACTOR".

WITNESSETH: That for and in consideration of the payments and agreements hereinafter mentioned:

1. The CONTRACTOR will commence and complete the construction of

**STREET IMPROVEMENTS
ANGEL STREET, PARKER STREET, VINE STREET, BRYANT STREET, & 4TH AVENUE (FROM CEDAR STREET TO THE TOWN LIMITS)**

2. The CONTRACTOR will furnish all of the material, supplies, tools, equipment, labor and other services necessary for the construction and completion of the PROJECT described herein.

3. The CONTRACTOR will commence the work required by the CONTRACT DOCUMENTS within **10** calendar days after the date of the NOTICE TO PROCEED and will complete the same within **thirty (30)** calendar days unless the period for completion is extended otherwise by the CONTRACT DOCUMENTS.

4. The CONTRACTOR agrees to perform all of the WORK described in the CONTRACT DOCUMENTS and comply with the terms therein for the sum of _____, or as shown in the BID schedule.

5. The term "CONTRACT DOCUMENTS" means and includes the following:
 - (A) ADVERTISEMENT FOR BIDS
 - (B) INFORMATION FOR BIDDERS

- (C) BID
- (D) BID BOND
- (E) AGREEMENT
- (F) GENERAL CONDITIONS
- (G) SUPPLEMENTAL GENERAL CONDITIONS
- (H) PAYMENT BOND
- (I) PERFORMANCE BOND
- (J) NOTICE OF AWARD
- (K) NOTICE TO PROCEED
- (L) CHANGE ORDER
- (M) DRAWINGS prepared by **Southern Engineering Solutions, Inc.** numbered **1** through **8**, and dated **July, 2020**
- (N) SPECIFICATIONS prepared or issued by **Southern Engineering Solutions, Inc.**, dated **July, 2020**
- (O) ADDENDA
 - No. _____, dated _____, 20__
 - No. _____, dated _____, 20__
 - No. _____, dated _____, 20__
 - No. _____, dated _____, 20__

6. The OWNER will pay to the CONTRACTOR in the manner and at such times as set forth in the General Conditions such amounts as required by the CONTRACT DOCUMENTS.

7. This AGREEMENT shall be binding upon all parties hereto and their respective heirs, executors, administrators, successors, and assigns.

IN WITNESS WHEREOF, the parties hereto have executed, or caused to be executed by their duly authorized officials, this Agreement in five (5) each of which shall be deemed an original on the date first above written.

OWNER:

_____ Town of Beatrice _____

BY: _____

Name: Annie M. Shelton
(Please Type)

Title: Mayor _____

(SEAL)

ATTEST:

Name: Alyssa House
(Please Type)

Title: Town Clerk _____

CONTRACTOR:

BY: _____

Name: _____
(Please Type)

(SEAL)

Address: _____

ATTEST:

Name: _____
(Please Type)

PAYMENT BOND

KNOW ALL MEN BY THESE PRESENTS: that

(Name of Contractor)

a _____, herein called Principal, and

(Name of Surety)

(Address of Surety)

hereinafter called Surety, are held and firmly bound unto

**Town of Beatrice
P O Box 56; Beatrice, Alabama 36425**

hereinafter called OWNER, in the penal sum of _____ Dollars, \$(_____) in lawful money of the United States, for the payment of which sum well and truly to be made, we bind ourselves, successors, and assigns, jointly and severally, firmly by these presents.

THE CONDITION OF THIS OBLIGATION is such that whereas, the Principal entered into a certain contract with the OWNER, dated the _____ day of _____, 2020, a copy of which is hereto attached and made a part hereof for the construction of:

**STREET IMPROVEMENTS
ANGEL STREET, PARKER STREET, VINE STREET, BRYANT STREET, & 4TH AVENUE (FROM CEDAR STREET TO THE TOWN LIMITS)**

NOW, THEREFORE, if the Principal shall promptly make payment to all persons, firms, SUBCONTRACTORS, and corporations furnishing materials for or performing labor in the prosecution of the WORK provided for in such contract, and any authorized extension or modification thereof, including all amounts due for materials, lubricants, oil, gasoline, coal and coke, repairs on machinery, equipment and tools, consumed or used in connection with the construction of such WORK, and all insurance premiums on said WORK, and for all labor, performed in such WORK whether by SUBCONTRACTOR or otherwise, then this obligation shall be void; otherwise to remain in full force and effect.

PROVIDED, FURTHER, that the said Surety for value received hereby stipulates and agrees that no change, extension of time, alteration or addition to the terms of the contract or to the WORK to be performed thereunder or the SPECIFICATIONS accompanying the same shall in any wise affect its obligation on this BOND, and it does hereby waive notice of any such change, extension of time, alteration or addition to the terms of the contract or to the WORK or to the SPECIFICATIONS.

PROVIDED, FURTHER, that no final settlement between the OWNER and the CONTRACTOR shall abridge the right of any beneficiary hereunder, whose claim may be unsatisfied.

IN WITNESS WHEREOF, this instrument is executed in **five (5)** counterparts, each one of which shall be deemed an original, this the _____ day of _____, 2020.

ATTEST:

(Principal) Secretary

Principal

(SEAL)

By _____ (s)

Witness as to Principal

(Address)

(Address)

ATTEST:

(Surety) Secretary

Surety

(SEAL)

By _____

Witness as to Surety

Attorney-in-Fact

(Address)

(Address)

NOTE: Date of BOND must not be prior to date of Contract.
If CONTRACTOR is Partnership, all partners should execute BOND.

IMPORTANT: Surety companies executing BONDS must appear on the Treasury Department's most current list (Circular 570 as amended) and be authorized to transact business in the State where the PROJECT is located.

PERFORMANCE BOND

KNOW ALL MEN BY THESE PRESENTS: that

(Name of Contractor)

a _____, hereinafter called Principal, and
(Corporation, Partnership, or Individual)

(Name of Surety)

(Address of Surety)

hereinafter called Surety, are held and firmly bound unto

**Town of Beatrice
P O Box 56; Beatrice, Alabama 36425**

hereinafter called OWNER, in the penal sum of _____ Dollars, \$(____) in lawful money of the United States, for the payment of which sum well and truly to be made, we bind ourselves, successors, and assigns, jointly and severally, firmly by these presents.

THE CONDITION OF THIS OBLIGATION is such that whereas, the Principal entered into a certain contract with the OWNER, dated the _____ day of _____, 2020, a copy of which is hereto attached and made a part hereof for the construction of:

**STREET IMPROVEMENTS
ANGEL STREET, PARKER STREET, VINE STREET, BRYANT STREET, & 4TH AVENUE (FROM CEDAR STREET TO THE TOWN LIMITS)**

NOW, THEREFORE, if the Principal shall well, truly and faithfully perform its duties, all the undertakings, covenants, terms, conditions, and agreements of said contract during the original term thereof, and any extensions thereof which may be granted by the OWNER, with or without notice to the Surety and during the one year guaranty period, and if he shall satisfy all claims and demands incurred under such contract, and shall fully indemnify and save harmless the OWNER from all costs and damages which it may suffer by reason of failure to do so, and shall reimburse and repay the OWNER all outlay and expense which the OWNER may incur in making good any default, then this obligation shall be void; otherwise to remain in full force and effect.

PROVIDED, FURTHER, that the said surety, for value received hereby stipulates and agrees that no change, extension of time, alteration or addition to the terms of the contract or to WORK to be performed thereunder or the SPECIFICATIONS accompanying the same shall in any wise affect its obligation on this BOND, and it does hereby waive notice of any such change, extension of time, alteration or addition to the terms of the contract or to the WORK or to the SPECIFICATIONS.

PROVIDED, FURTHER, that no final settlement between the OWNER and the CONTRACTOR shall abridge the right of any beneficiary hereunder, whose claim may be unsatisfied.

IN WITNESS WHEREOF, this instrument is executed in **five (5)** counterparts, each on of which shall be deemed an original, this the _____ day of _____, 2020.

ATTEST:

(Principal) Secretary

Principal

(SEAL)

By _____ (s)

Witness as to Principal

(Address)

(Address)

ATTEST:

(Surety) Secretary

Surety

(SEAL)

By _____

Witness as to Surety

Attorney-in-Fact

(Address)

(Address)

NOTE: Date of BOND must not be prior to date of Contract.

If CONTRACTOR is Partnership, all partners should execute BOND.

IMPORTANT: Surety companies executing BONDS must appear on the Treasury Department's most current list (Circular 570 as amended) and be authorized to transact business in the state where the PROJECT is located.

NOTICE OF AWARD

To:

PROJECT Description: **STREET IMPROVEMENTS – ANGEL STREET, PARKER STREET, VINE STREET, BRYANT STREET, & 4TH AVENUE (FROM CEDAR STREET TO THE TOWN LIMITS)**

The OWNER has considered the BID submitted by you for the above described WORK in response to its Advertisement for Bids dated _____, 2020, and Information for Bidders.

You are hereby notified that your BID has been accepted for items in the amount of \$_____.

You are required by the Information for Bidders to execute the Agreement and furnish the required CONTRACTOR'S Performance BOND, Payment BOND and certificates of insurance within five (5) calendar days from the date of this Notice to you.

If you fail to execute said Agreement and to furnish said BONDS within five (5) days from the date of this Notice, said OWNER will be entitled to consider all your rights arising out of the OWNER'S acceptance of your BID as abandoned and as a forfeiture of your BID BOND. The OWNER will be entitled to such other rights as may be granted by law.

You are required to return an acknowledged copy of this NOTICE OF AWARD to the OWNER.

Dated this ____ day of _____, 2020.

Town of Beatrice
Owner

By _____
Annie M. Shelton

Title Mayor

ACCEPTANCE OF NOTICE

Receipt of the above NOTICE OF AWARD is hereby acknowledged

by _____,

this the _____ day _____, 2020

By _____

Title _____

NOTICE TO PROCEED

To: _____ Date: _____

PROJECT Description: **STREET IMPROVEMENTS – ANGEL STREET, PARKER STREET, VINE STREET, BRYANT STREET, & 4TH AVENUE (FROM CEDAR STREET TO THE TOWN LIMITS)**

You are hereby notified to commence WORK in accordance with the Agreement dated _____, 2020, on or before _____, 2020, and you are to complete the WORK within **thirty (30)** consecutive calendar days thereafter.

The date of completion of all WORK is therefore _____, 20__.

Town of Beatrice
Owner

By _____
Annie M. Shelton

Title Mayor _____

ACCEPTANCE OF NOTICE

Receipt of the above NOTICE OF AWARD is hereby acknowledged

by _____,

this the _____ day _____, 2020

By _____

Title _____

CHANGE ORDER

Order No.

Date:

Agreement Date:

NAME OF PROJECT:

OWNER:

CONTRACTOR:

The following changes are hereby made to the CONTRACT DOCUMENTS:

Justification:

Change to CONTRACT PRICE:

Original CONTRACT PRICE: \$

Current CONTRACT PRICE adjusted by previous CHANGE ORDER \$

The CONTRACT PRICE including this CHANGE ORDER will be (increased) (decreased) by:
\$

The new CONTRACT PRICE including this CHANGE ORDER will be \$

Change to CONTRACT TIME:

The CONTRACT TIME will be (increased) (decreased) by _____ calendar days.

The date for completion of all work will be _____(Date).

Approvals Required:

To be effective this Order must be approved by the Federal agency if it changes the scope or objective of the PROJECT, or as may otherwise be required by the SUPPLEMENTAL GENERAL CONDITIONS.

Requested by:

Recommended by:

Ordered by:

Accepted by:

Federal Agency Approval (where applicable)

CERTIFICATION BY OWNER

I, the undersigned, Annie M Shelton, the duly authorized and acting official representative of

Town of Beatrice do hereby certify as follows:

This contract is let in compliance with the provisions of Title 39, Code of Alabama (1975, as amended), and all other applicable provisions of law.

Signature _____

Title Mayor

Date _____

GENERAL CONDITIONS

1. Definitions
2. Additional Instructions and Detail Drawings
3. Schedules, Reports and Records
4. Drawings and Specifications
5. Shop Drawings
6. Materials, Services and Facilities
7. Inspection and Testing
8. Substitutions
9. Patents
10. Surveys, Permits, Regulations
11. Protection of Work, Property, Persons
12. Supervision by Contractor
13. Changes in the Work
14. Changes in the Contract Price
15. Time for Completion and Liquidated Damages
16. Correction of Work
17. Subsurface Conditions
18. Suspension of Work, Termination and Delay
19. Payments to Contractor
20. Acceptance of Final Payment as Release
21. Insurance
22. Contract Security
23. Assignments
24. Indemnification
25. Separate Contracts
26. Subcontracting
27. Engineer's Authority
28. Land and Rights of Way
29. Guaranty
30. Governing Law and Dispute Resolution
31. Taxes

1. DEFINITIONS

- 1.1 Wherever used in the CONTRACT DOCUMENTS, the following terms shall have the meanings indicated which shall be applicable to both the singular and plural thereof:
- 1.2 ADDENDA -- Written or graphic instruments issued prior to the execution of the Agreement which modify or interpret the CONTRACT DOCUMENTS, DRAWINGS and SPECIFICATIONS, by additions, deletions, clarifications or corrections.
- 1.3 BID -- The offer or proposal of the BIDDER submitted on the prescribed form setting forth the prices for the WORK to be performed.
- 1.4 BIDDER -- Any person, firm or corporation submitting a BID for the WORK.
- 1.5 BONDS -- Bid, Performance, and Payment Bonds and other instruments of security, furnished by the CONTRACTOR and his surety in accordance with the CONTRACT DOCUMENTS.
- 1.6 CHANGE ORDER -- A written order to the CONTRACTOR authorizing an addition, deletion or revision in the WORK within the general scope of the CONTRACT DOCUMENTS, or authorizing an adjustment in the CONTRACT PRICE or CONTRACT TIME.
- 1.7 CONTRACT DOCUMENTS -- The contract, including Advertisement For Bids, Information for Bidders, BID, Bid Bond, Agreement, Payment Bond, Performance Bond, NOTICE OF AWARD, NOTICE TO PROCEED, CHANGE ORDER, DRAWINGS, SPECIFICATIONS, and ADDENDA.
- 1.8 CONTRACT PRICE -- The total monies payable to the CONTRACTOR under the terms and conditions of the CONTRACT DOCUMENTS.
- 1.9 CONTRACT TIME -- The number of calendar days stated in the CONTRACT DOCUMENTS for the completion of the WORK.
- 1.10 CONTRACTOR -- The person, firm or corporation with whom the OWNER has executed the Agreement.
- 1.11 DRAWINGS -- The part of the CONTRACT DOCUMENTS which show the characteristics and scope of the WORK to be performed and which have been prepared or approved by the ENGINEER.

- 1.12 ENGINEER -- The person, firm or corporation named as such in the CONTRACT DOCUMENTS.
- 1.13 FIELD ORDER -- A written order effecting a change in the WORK not involving an adjustment in the CONTRACT PRICE or an extension of the CONTRACT TIME, issued by the ENGINEER to the CONTRACTOR during construction.
- 1.14 NOTICE OF AWARD -- The written notice of the acceptance of the BID from the OWNER to the successful BIDDER.
- 1.15 NOTICE TO PROCEED -- Written communication issued by the OWNER to the CONTRACTOR authorizing him to proceed with the WORK and establishing the date of commencement of the WORK.
- 1.16 OWNER -- A public or quasi-public body or authority, corporation, association, partnership, or individual for whom the WORK is to be performed.
- 1.17 PROJECT -- The undertaking to be performed as provided in the CONTRACT DOCUMENTS.
- 1.18 RESIDENT PROJECT REPRESENTATIVE -- The authorized representative of the OWNER who is assigned to the PROJECT site or any part thereof.
- 1.19 SHOP DRAWINGS -- All drawings, diagrams, illustrations, brochures, schedules and other data which are prepared by the CONTRACTOR, a SUBCONTRACTOR, manufacturer, SUPPLIER or distributor, which illustrate how specific portions of the WORK shall be fabricated or installed.
- 1.20 SPECIFICATIONS -- A part of the CONTRACT DOCUMENTS consisting of written descriptions of a technical nature of materials, equipment, construction systems, standards and workmanship.
- 1.21 SUBCONTRACTOR -- An individual, firm or corporation having a direct contract with the CONTRACTOR or with any other SUBCONTRACTOR for the performance of a part of the work at the site.
- 1.22 SUBSTANTIAL COMPLETION -- That date as certified by the ENGINEER when the construction of the PROJECT or a specified part thereof is sufficiently completed, in accordance with the CONTRACT DOCUMENTS, so that the PROJECT or specified part can be utilized for the purposes for which it is intended.
- 1.23 SUPPLEMENTAL GENERAL CONDITIONS -- Modifications to General Conditions required by a Federal agency for participation in the PROJECT and approved by the agency in writing prior to inclusion in the CONTRACT DOCUMENTS, or such requirements that may be imposed by applicable state laws.
- 1.24 SUPPLIER -- Any person or organization who supplies materials or equipment for the WORK, including that fabricated to a special design, but who does not perform labor at the site.
- 1.25 WORK -- All labor necessary to produce the construction required by the CONTRACT DOCUMENTS, and all materials and equipment incorporated or to be incorporated in the PROJECT.
- 1.26 WRITTEN NOTICE--Any notice to any party of the Agreement relative to any part of this Agreement in writing and considered delivered and the service thereof completed, when posted by certified or registered mail to the said party at his last given address, or delivered in person to said party or his authorized representative on the WORK.

2. ADDITIONAL INSTRUCTIONS AND DETAIL DRAWINGS

- 2.1 The CONTRACTOR may be furnished additional instructions and detail drawings, by the ENGINEER, as necessary to carry out the WORK required by the CONTRACT DOCUMENTS.
- 2.2 The additional drawings and instruction thus supplied will become a part of the CONTRACT DOCUMENTS. The CONTRACTOR shall carry out the WORK in accordance with the additional detail drawings and instructions.

3. SCHEDULES, REPORTS AND RECORDS

- 3.1 The CONTRACTOR shall submit to the OWNER such schedule of quantities and costs, progress schedules, payrolls, reports, estimates, records and other data where applicable as are required by the CONTRACT DOCUMENTS for the WORK to be performed.
- 3.2 Prior to the first partial payment estimate the CONTRACTOR shall submit construction progress schedules showing the order in which he proposes to carry on the WORK, including dates at which he will start the various parts of the WORK, estimated date of completion of each part and, as applicable:
 - 3.2.1 The dates at which special detail drawings will be required; and
 - 3.2.2 Respective dates for submission of SHOP DRAWINGS, the beginning of manufacture, the testing and the installation of materials, supplies and equipment.
- 3.3 The CONTRACTOR shall also submit a schedule of payments that he anticipates he will earn during the course of the WORK.

4. DRAWINGS AND SPECIFICATIONS

- 4.1 The intent of the DRAWINGS and SPECIFICATIONS is that the CONTRACTOR shall furnish all labor, materials, tools, equipment, and transportation necessary for the proper execution of the WORK in accordance with the CONTRACT DOCUMENTS and all incidental work necessary to complete the PROJECT in an acceptable manner, ready for use, occupancy or operation by the OWNER.
- 4.2 In case of conflict between the DRAWINGS and SPECIFICATIONS, the SPECIFICATIONS shall govern. Figure dimensions on DRAWINGS shall govern over scale dimensions, and detailed DRAWINGS shall govern over general DRAWINGS.
- 4.3 Any discrepancies found between the DRAWINGS and SPECIFICATIONS and site conditions or any inconsistencies or ambiguities in the DRAWINGS or SPECIFICATIONS shall be immediately reported to the ENGINEER, in writing, who shall promptly correct such inconsistencies or ambiguities in writing. WORK done by the CONTRACTOR after his discovery of such discrepancies, inconsistencies or ambiguities shall be done at the CONTRACTOR'S risk.

5. SHOP DRAWINGS

- 5.1 The CONTRACTOR shall provide SHOP DRAWINGS as may be necessary for the prosecution of the WORK as required by the CONTRACT DOCUMENTS. The ENGINEER shall promptly review all SHOP DRAWINGS. The ENGINEER'S approval of any SHOP DRAWING shall not release the CONTRACTOR from responsibility for deviations from the CONTRACT DOCUMENTS. The approval of any SHOP DRAWING which substantially deviates from the requirement of the CONTRACT DOCUMENTS shall be evidenced by a CHANGE ORDER.
- 5.2 When submitted for the ENGINEER'S review, SHOP DRAWINGS shall bear the CONTRACTOR'S certification that he has reviewed, checked and approved the SHOP DRAWINGS and that they are in conformance with the requirements of the CONTRACT DOCUMENTS.
- 5.3 Portions of the WORK requiring a SHOP DRAWING or sample submission shall not begin until the SHOP DRAWING or submission has been approved by the ENGINEER. A copy of each approved SHOP DRAWING and each approved sample shall be kept in good order by the CONTRACTOR at the site and shall be available to the ENGINEER.

6. MATERIALS, SERVICES AND FACILITIES

- 6.1 It is understood that, except as otherwise specifically stated in the CONTRACT DOCUMENTS, the CONTRACTOR shall provide and pay for all materials, labor, tools, equipment, water, light, power, transportation, supervision, temporary construction of any nature, and all other services and facilities of any nature whatsoever necessary to execute, complete, and deliver the WORK within the specified time.
- 6.2 Materials and equipment shall be so stored as to insure the preservation of their quality and fitness for the WORK. Stored materials and equipment to be incorporated in the WORK shall be located so as to facilitate prompt inspection.
- 6.3 Manufactured articles, materials and equipment shall be applied, installed, connected, erected, used, cleaned and conditioned as directed by the manufacturer.
- 6.4 Materials, supplies and equipment shall be in accordance with samples submitted by the CONTRACTOR and approved by the ENGINEER.
- 6.5 Materials, supplies or equipment to be incorporated into the WORK shall not be purchased by the CONTRACTOR or the SUBCONTRACTOR subject to a chattel mortgage or under a conditional sale contract or other agreement by which an interest is retained by the seller.

7. INSPECTION AND TESTING

- 7.1 All materials and equipment used in the construction of the PROJECT shall be subject to adequate inspection and testing in accordance with generally accepted standards, as required and defined in the CONTRACT DOCUMENTS.
- 7.2 The OWNER shall provide all inspection and testing services not required by the CONTRACT DOCUMENTS.
- 7.3 The CONTRACTOR shall provide at his expense the testing and inspection services required by the CONTRACT DOCUMENTS.
- 7.4 If the CONTRACT DOCUMENTS, laws, ordinances, rules, regulations or orders of any public authority having jurisdiction require any WORK to specifically be inspected, tested, or approved by someone other than the CONTRACTOR, the CONTRACTOR will give the ENGINEER timely notice of readiness. The CONTRACTOR will then furnish the ENGINEER the required certificates of inspection, testing or approval.
- 7.5 Inspections, tests or approvals by the engineer or others shall not relieve the CONTRACTOR from his obligations to perform the WORK in accordance with the requirements of the CONTRACT DOCUMENTS.
- 7.6 The ENGINEER and his representatives will at all times have access to the WORK. In addition, authorized representatives and agents of any participating Federal or state agency shall be permitted to inspect all work, materials, payrolls, records of personnel, invoices of materials, and other relevant data and records. The CONTRACTOR will provide proper facilities for such access and observation of the WORK and also for any inspection, or testing thereof.
- 7.7 If any WORK is covered contrary to the written instructions of the ENGINEER it must, if requested by the ENGINEER, be uncovered for his observation and replaced at the CONTRACTOR'S expense.
- 7.8 If the ENGINEER considers it necessary or advisable that covered WORK be inspected or tested by others, the CONTRACTOR, at the ENGINEER'S request, will uncover, expose or otherwise make available for observation, inspection or testing as the ENGINEER may require, that portion of the WORK in question, furnishing all necessary labor, materials, tools, and equipment. If it is found that such WORK is defective, the CONTRACTOR will bear all the expenses of such uncovering, exposure, observation, inspection and testing and of satisfactory reconstruction. If, however, such WORK is not found to be defective, the CONTRACTOR will be allowed an increase in the CONTRACT PRICE or an extension of the CONTRACT TIME, or both, directly attributable to such

uncovering, exposure, observation, inspection, testing and reconstruction and an appropriate CHANGE ORDER shall be issued.

8. SUBSTITUTIONS

- 8.1 Whenever a material, article or piece of equipment is identified on the DRAWINGS or SPECIFICATIONS by reference to brand name or catalogue number, it shall be understood that this is referenced for the purpose of defining the performance or other salient requirements and that other products of equal capacities, quality and function shall be considered. The CONTRACTOR may recommend the substitution of a material, article, or piece of equipment of equal substance and function for those referred to in the CONTRACT DOCUMENTS by reference to brand name or catalogue number, and if, in the opinion of the ENGINEER, such material, article, or piece of equipment is of equal substance and function to that specified, the ENGINEER may approve its substitution and use by the CONTRACTOR. Any cost differential shall be deductible from the CONTRACT PRICE and the CONTRACT DOCUMENTS shall be appropriately modified by CHANGE ORDER. The CONTRACTOR warrants that if substitutes are approved, no major changes in the function or general design of the PROJECT will result. Incidental changes or extra component parts required to accommodate the substitute will be made by the CONTRACTOR without a change in the CONTRACT PRICE or CONTRACT TIME.

9. PATENTS

- 9.1 The CONTRACTOR shall pay all applicable royalties and license fees. He shall defend all suits or claims for infringement of any patent rights and save the OWNER harmless from loss on account thereof, except that the OWNER shall be responsible for any such loss when a particular process, design, or the product of a particular manufacturer or manufacturers is specified, however if the CONTRACTOR has reason to believe that the design, process or product specified is an infringement of a patent, he shall be responsible for such loss unless he promptly gives such information to the ENGINEER.

10. SURVEYS, PERMITS, REGULATIONS

- 10.1 The OWNER shall furnish all boundary surveys and establish all base lines for locating the principal component parts of the WORK together with a suitable number of bench marks adjacent to the WORK as shown in the CONTRACT DOCUMENTS. From the information provided by the OWNER, unless otherwise specified in the CONTRACT DOCUMENTS, the CONTRACTOR shall develop and make all detail surveys needed for construction such as slope stakes, batter boards, stakes for pile locations and other working points, lines, elevations and cut sheets.
- 10.2 The CONTRACTOR shall carefully preserve bench marks, reference points and stakes and, in case of willful or careless destruction, he shall be charged with the resulting expense and shall be responsible for any mistakes that may be caused by their unnecessary loss or disturbance.
- 10.3 Permits and licenses of a temporary nature necessary for the prosecution of the WORK shall be secured and paid for by the CONTRACTOR unless otherwise stated in the SUPPLEMENTAL GENERAL CONDITIONS. Permits, licenses and easements for permanent structures or permanent changes in existing facilities shall be secured and paid for by the OWNER, unless otherwise specified. The CONTRACTOR shall give all notices and comply with all laws, ordinances, rules and regulations bearing on the conduct of the WORK as drawn and specified. If the CONTRACTOR observes that the CONTRACT DOCUMENTS are at variance therewith, he shall promptly notify the ENGINEER in writing, and any necessary changes shall be adjusted as provided in Section 13, CHANGES IN THE WORK.

11. PROTECTION OF WORK, PROPERTY AND PERSONS

- 11.1 The CONTRACTOR will be responsible for initiating, maintaining and supervising all safety precautions and programs in connection with the WORK. He will take all necessary precautions for the safety of, and will

provide the necessary protection to prevent damage, injury or loss to all employees on the WORK and other persons who may be affected thereby, all the WORK and all materials or equipment to be incorporated therein, whether in storage on or off the site, and other property at the site or adjacent thereto, including trees, shrubs, lawns, walks, pavements, roadways, structures and utilities not designated for removal, relocation or replacement in the course of construction.

- 11.2 The CONTRACTOR will comply with all applicable laws, ordinances, rules, regulations and orders of any public body having jurisdiction. He will erect and maintain, as required by the conditions and progress of the WORK, all necessary safeguards for safety and protection. He will notify owners of adjacent utilities when prosecution of the WORK may affect them. The CONTRACTOR will remedy all damage, injury or loss to any property caused, directly or indirectly, in whole or in part, by the CONTRACTOR, any SUBCONTRACTOR or anyone directly or indirectly employed by any of them or anyone for whose acts any of them be liable, except damage or loss attributable to the fault of the CONTRACT DOCUMENTS or to the acts or omissions of the OWNER or the ENGINEER or anyone employed by either of them or anyone for whose acts either of them may be liable, and not attributable, directly or indirectly, in whole or in part, to the fault or negligence of the CONTRACTOR.
- 11.3 In emergencies affecting the safety of persons or the WORK or property at the site or adjacent thereto, the CONTRACTOR, without special instruction or authorization from the ENGINEER or OWNER, shall act to prevent threatened damage, injury or loss. He will give the ENGINEER prompt WRITTEN NOTICE of any significant changes in the WORK or deviations from the CONTRACT DOCUMENTS caused thereby, and a CHANGE ORDER shall thereupon be issued covering the changes and deviations involved.

12. SUPERVISION BY CONTRACTOR

- 12.1 The CONTRACTOR will supervise and direct the WORK. He will be solely responsible for the means, methods, techniques, sequences and procedures of construction. The CONTRACTOR will employ and maintain on the WORK a qualified supervisor or superintendent who shall have been designated in writing by the CONTRACTOR as the CONTRACTOR'S representative at the site. The supervisor shall have full authority to act on behalf of the CONTRACTOR and all communications given to the supervisor shall be as binding as if given to the CONTRACTOR. The supervisor shall be present on the site at all times as required to perform adequate supervision and coordination of the WORK.

13. CHANGES IN THE WORK

- 13.1 The OWNER may at any time, as the need arises, order changes within the scope of the WORK without invalidating the Agreement. If such changes increase or decrease the amount due under the CONTRACT DOCUMENTS, or in the time required for performance of the WORK, an equitable adjustment shall be authorized by CHANGE ORDER.
- 13.2 The ENGINEER, also, may at any time, by issuing a FIELD ORDER, make changes in the details of the WORK. The CONTRACTOR shall proceed with the performance of any changes in the WORK so ordered by the ENGINEER unless the CONTRACTOR believes that such FIELD ORDER entitles him to a change in CONTRACT PRICE or TIME, or both, in which event he shall give the ENGINEER WRITTEN NOTICE thereof within seven (7) days after the receipt of the ordered change. Thereafter the CONTRACTOR shall document the basis for the change in CONTRACT PRICE or TIME within thirty (30) days. The CONTRACTOR shall not execute such changes pending the receipt of an executed CHANGE ORDER or further instruction from the OWNER.

14. CHANGES IN CONTRACT PRICE

- 14.1 The CONTRACT PRICE may be changed only by a CHANGE ORDER. The value of any WORK covered by a CHANGE ORDER or of any claim for increase or decrease in the CONTRACT PRICE shall be determined by one or more of the following methods in the order of precedence listed below:

- (a) Unit prices previously approved.
- (b) An agreed lump sum.
- (c) The actual cost for labor, direct overhead, materials, supplies, equipment, and other services necessary to complete the work. In addition there shall be added an amount to be agreed upon but not to exceed fifteen (15) percent of the actual cost of the WORK to cover the cost of general overhead and profit.

15. TIME FOR COMPLETION AND LIQUIDATED DAMAGES

- 15.1 The date of beginning and the time for completion of the WORK are essential conditions of the CONTRACT DOCUMENTS and the WORK embraced shall be commenced on a date specified in the NOTICE TO PROCEED.
- 15.2 The CONTRACTOR will proceed with the WORK at such rate of progress to insure full completion within the CONTRACT TIME. It is expressly understood and agreed, by and between the CONTRACTOR and the OWNER, that the CONTRACT TIME for the completion of the WORK described herein is a reasonable time, taking into consideration the average climatic and economic conditions and other factors prevailing in the locality of the WORK.
- 15.3 If the CONTRACTOR shall fail to complete the WORK within the CONTRACT TIME, or extension of time granted by the OWNER, then the CONTRACTOR will pay to the OWNER the amount for liquidated damages as specified in the BID for each calendar day that the CONTRACTOR shall be in default after the time stipulated in the CONTRACT DOCUMENTS.
- 15.4 The CONTRACTOR shall not be charged with liquidated damages or any excess cost when the delay in completion of the WORK is due to the following, and the CONTRACTOR has promptly given WRITTEN NOTICE of such delay to the OWNER or ENGINEER.
 - 15.4.1 To any preference, priority or allocation order duly issued by the OWNER.
 - 15.4.2 To unforeseeable causes beyond the control and without the fault or negligence of the CONTRACTOR, including but not restricted to, acts of God, or of the public enemy, acts of the OWNER, acts of another CONTRACTOR in the performance of a contract with the OWNER, fires, floods, epidemics, quarantine restrictions, strikes, freight embargoes, and abnormal and unforeseeable weather: and
 - 15.4.3 To any delays of SUBCONTRACTORS occasioned by any of the causes specified in paragraphs 15.4.1 and 15.4.2 of this article.

16. CORRECTION OF WORK

- 16.1 The CONTRACTOR shall promptly remove from the premises all WORK rejected by the ENGINEER for failure to comply with the CONTRACT DOCUMENTS, whether incorporated in the construction or not, and the CONTRACTOR shall promptly replace and re-execute the WORK in accordance with the CONTRACT DOCUMENTS and without expense to the OWNER and shall bear the expense of making good all WORK of other CONTRACTORS destroyed or damaged by such removal or replacement.
- 16.2 All removal and replacement WORK shall be done at the CONTRACTOR'S expense. If the CONTRACTOR does not take action to remove such rejected WORK within ten (10) days after receipt of WRITTEN NOTICE, the OWNER may remove such WORK and store the materials at the expense of the CONTRACTOR.

17. SUBSURFACE CONDITIONS

- 17.1 The CONTRACTOR shall promptly, and before such conditions are disturbed, except in the event of an emergency, notify the OWNER by WRITTEN NOTICE of:

- 17.1.1 Subsurface or latent physical conditions at the site differing materially from those indicated in the CONTRACT DOCUMENTS: or
- 17.1.2 Unknown physical conditions at the site, of an unusual nature, differing materially from those ordinarily encountered and generally recognized as inherent in WORK of the character provided for in the CONTRACT DOCUMENTS.
- 17.2 The OWNER shall promptly investigate the conditions, and if he finds that such conditions do so materially differ and cause an increase or decrease in the cost of, or in the time required for, performance of the WORK, an equitable adjustment shall be made and the CONTRACT DOCUMENTS shall be modified by a CHANGE ORDER. Any claim of the CONTRACTOR for adjustment hereunder shall not be allowed unless he has given the required WRITTEN NOTICE; provided that the OWNER may, if he determines the facts so justify, consider and adjust any such claims asserted before the date of final payment.
- 18. SUSPENSION OF WORK, TERMINATION AND DELAY**
- 18.1 The OWNER may suspend the WORK or any portion thereof for a period of not more than ninety days or such further time as agreed upon by the CONTRACTOR by WRITTEN NOTICE to the CONTRACTOR and the ENGINEER which notice shall fix the date on which WORK shall be resumed. The CONTRACTOR will resume that WORK on the date so fixed. The CONTRACTOR will be allowed an increase in the CONTRACT PRICE or an extension of the CONTRACT TIME, or both, directly attributable to any suspension.
- 18.2 If the CONTRACTOR is adjudged as bankrupt or insolvent, or if he makes a general assignment for the benefit of his creditors, or if a trustee or receiver is appointed for the CONTRACTOR or for any of his property, or if he files a petition to take advantage of any debtor's act, or to reorganize under the bankruptcy or applicable laws, or if he repeatedly fails to supply sufficient skilled workmen or suitable materials or equipment, or if he repeatedly fails to make prompt payments to SUBCONTRACTORS or for labor, materials or equipment or if he disregards laws, ordinances, rules, regulations or orders of any public body having jurisdiction of the WORK or if he disregards the authority of the ENGINEER, or if he otherwise violates any provision of the CONTRACT DOCUMENTS, then the OWNER may, without prejudice to any other right or remedy and after giving the CONTRACTOR and his surety a minimum of ten (10) days from delivery of a WRITTEN NOTICE, terminate the services of the CONTRACTOR and take possession of the PROJECT and of all materials, equipment, tools, construction equipment and machinery, thereon owned by the CONTRACTOR, and finish the WORK by whatever method he may deem expedient. In such case the CONTRACTOR shall not be entitled to receive any further payment until the WORK is finished. If the unpaid balance of the CONTRACT PRICE exceeds the direct and indirect costs of completing the PROJECT, including compensation for additional professional services, such excess SHALL BE PAID TO THE CONTRACTOR. If such costs exceed such unpaid balance, the CONTRACTOR will pay the difference to the OWNER. Such costs incurred by the OWNER will be determined by the ENGINEER and incorporated in a CHANGE ORDER.
- 18.3 Where the CONTRACTOR'S services have been so terminated by the OWNER, said termination shall not affect any right of the OWNER against the CONTRACTOR then existing or which may thereafter accrue. Any retention or payment of monies by the OWNER due the CONTRACTOR will not release the CONTRACTOR from compliance with the CONTRACT DOCUMENTS.
- 18.4 After ten (10) days from delivery of a WRITTEN NOTICE to the CONTRACTOR and the ENGINEER, the OWNER may, without cause and without prejudice to any other right or remedy, elect to abandon the PROJECT and terminate the Contract. In such case, the CONTRACTOR shall be paid for all WORK executed and any expense sustained plus reasonable profit.
- 18.5 If, through no act or fault of the CONTRACTOR, the WORK is suspended for a period of more than ninety (90) days by the OWNER or under an order of court or other public authority, or the ENGINEER fails to act on any request for payment within thirty (30) days after it is submitted or the OWNER fails to pay the CONTRACTOR substantially the sum approved by the ENGINEER or awarded by arbitrators within thirty (30) days of its approval and presentation, then the CONTRACTOR may, after ten (10) days from delivery of a WRITTEN NOTICE to the OWNER and the ENGINEER, terminate the CONTRACT and recover from the OWNER payment for all

WORK executed and all expenses sustained. In addition and in lieu of terminating the CONTRACT, if the ENGINEER has failed to act on a request for payment or if the OWNER has failed to make any payment as aforesaid, the CONTRACTOR may upon ten (10) days written notice to the OWNER and the ENGINEER stop the WORK until he has been paid all amounts then due, in which event and upon resumption of the WORK, CHANGE ORDERS shall be issued for adjusting the CONTRACT PRICE or extending the CONTRACT TIME or both to compensate for the costs and delays attributable to the stoppage of the WORK.

- 18.6 If the performance of all or any portion of the WORK is suspended, delayed, or interrupted as a result of a failure of the OWNER or ENGINEER to act within the time specified in the CONTRACT DOCUMENTS, or if no time is specified, within a reasonable time, an adjustment in the CONTRACT PRICE or an extension of the CONTRACT TIME, or both, shall be made by CHANGE ORDER to compensate the CONTRACTOR for the costs and delays necessarily caused by the failure of the OWNER or ENGINEER.

19. PAYMENTS TO CONTRACTOR

- 19.1 At least ten (10) days before each progress payment falls due (but not more often than once a month), the CONTRACTOR will submit to the ENGINEER a partial payment estimate filled out and signed by the CONTRACTOR covering the WORK performed during the period covered by the partial payment estimate and supported by such data as the ENGINEER may reasonably require. If payment is requested on the basis of materials and equipment not incorporated in the WORK but delivered and suitably stored at or near the site, the partial payment estimate shall also be accompanied by such supporting data, satisfactory to the OWNER, as will establish the OWNER's title to the material and equipment and protect his interest therein, including applicable insurance. The ENGINEER will, within ten (10) days after receipt of each partial payment estimate, either indicate in writing his approval of payment and present the partial payment estimate to the OWNER, or return the partial payment estimate to the CONTRACTOR indicating in writing his reasons for refusing to approve payment. In the latter case, the CONTRACTOR may make the necessary corrections and resubmit the partial payment estimate. The OWNER will, within ten (10) days of presentation to him of an approved partial payment estimate, pay the CONTRACTOR a progress payment on the basis of the approved partial payment estimate. The OWNER shall retain ten (10) percent of the amount of each payment until final completion and acceptance of all work covered by the CONTRACT DOCUMENTS. The OWNER at any time, however, after fifty (50) percent of the WORK has been completed, if he finds that satisfactory progress is being made, shall reduce retainage to five (5%) percent on the current and remaining estimates. When the WORK is substantially complete (operational or beneficial occupancy), the retained amount may be further reduced below five (5) percent to only that amount necessary to assure completion. On completion and acceptance of a part of the WORK on which the price is stated separately in the CONTRACT DOCUMENTS, payment may be made in full, including retained percentages, less authorized deductions.
- 19.2 The request for payment may also include an allowance for the cost of such major materials and equipment which are suitably, stored either at or near the site.
- 19.3 Prior to SUBSTANTIAL COMPLETION, the OWNER, with the approval of the ENGINEER and with the concurrence of the CONTRACTOR, may use any completed or substantially completed portions of the WORK. Such use shall not constitute an acceptance of such portions of the WORK.
- 19.4 The OWNER shall have the right to enter the premises for the purpose of doing work not covered by the CONTRACT DOCUMENTS. This provision shall not be construed as relieving the CONTRACTOR of the sole responsibility for the care and protection of the WORK, or the restoration of any damaged WORK except such as may be caused by agents or employees of the OWNER.
- 19.5 Upon completion and acceptance of the WORK, the ENGINEER shall issue a certificate attached to the final payment request that the WORK has been accepted by him under the conditions of the CONTRACT DOCUMENTS. The entire balance found to be due the CONTRACTOR, including the retained percentages, but except such sums as may be lawfully retained by the OWNER, shall be paid to the CONTRACTOR within thirty (30) days of completion and acceptance of the WORK.

- 19.6 The CONTRACTOR will indemnify and save the OWNER or the OWNER'S agents harmless from all claims growing out of the lawful demands of SUBCONTRACTORS, laborers, workmen, mechanics, materialmen, and furnishers of machinery and parts thereof, equipment, tools, and all supplies, incurred in the furtherance of the performance of the WORK. The CONTRACTOR shall, at the OWNER'S request, furnish satisfactory evidence that all obligations of the nature designated above have been paid, discharged, or waived. If the CONTRACTOR fails to do so the OWNER may, after having notified the CONTRACTOR, either pay unpaid bills or withhold from the CONTRACTOR'S unpaid compensation a sum of money deemed reasonably sufficient to pay any and all such lawful claims until satisfactory evidence is furnished that all liabilities have been fully discharged whereupon payment to the CONTRACTOR shall be resumed, in accordance, with the terms of the CONTRACT DOCUMENTS, but in no event shall the provisions of this sentence be construed to impose any obligations upon the OWNER to either the CONTRACTOR, his Surety, or any third party. In paying any unpaid bills of the CONTRACTOR, any payment so made by the OWNER shall be considered as a payment made under the CONTRACT DOCUMENTS by the OWNER to the CONTRACTOR and the OWNER shall not be liable to the CONTRACTOR for any such payments made in good faith.
- 19.7 If the OWNER fails to make payment thirty (30) days after approval by the ENGINEER, in addition to other remedies available to the CONTRACTOR, there shall be added to each such payment interest at the maximum legal rate commencing on the first day after said payment is due and continuing until the payment is received by the CONTRACTOR.

20. ACCEPTANCE OF FINAL PAYMENT AS RELEASE

- 20.1 The acceptance by the CONTRACTOR of final payment shall be and shall operate as a release to the OWNER of all claims and all liability to the CONTRACTOR other than claims in stated amounts as may be specifically excepted by the CONTRACTOR for all things done or furnished in connection with this WORK and for every act and neglect of the OWNER and others relating to or arising out of this WORK. Any payment, however, final or otherwise, shall not release the CONTRACTOR or his sureties from any obligations under the CONTRACT DOCUMENTS or the Performance BOND and Payment BONDS.

21. INSURANCE

- 21.1 The CONTRACTOR shall purchase and maintain such insurance as will protect him from claims set forth below which may arise out of or result from the CONTRACTOR'S execution of the WORK, whether such execution be by himself or by any SUBCONTRACTOR or by anyone directly or indirectly employed by any of them, or by anyone for whose acts any of them may be liable:
- 21.1.1 Claims under workmen's compensation disability benefit and other similar employee benefit acts;
 - 21.1.2 Claims for damages because of bodily injury, occupational sickness or disease, or death of his employees;
 - 21.1.3 Claims for damages because of bodily injury, sickness or disease, or death of any person other than his employees;
 - 21.1.4 Claims for damages insured by usual personal injury liability coverage which are sustained (1) by any person as a result of an offense directly or indirectly related to the employment of such person by the CONTRACTOR, or (2) by any other person; and
 - 21.1.5 Claims for damages because of injury to or destruction of tangible property, including loss of use resulting therefrom.
- 21.2 Certificates of Insurance acceptable to the OWNER shall be filed with the OWNER prior to commencement of the WORK. These Certificates shall contain a provision that coverages afforded under the policies will not be canceled unless at least fifteen (15) days prior WRITTEN NOTICE has been given to the OWNER.

- 21.3 The CONTRACTOR shall procure and maintain, at his own expense, during the CONTRACT TIME, liability insurance as hereinafter specified;
- 21.3.1 CONTRACTOR'S General Public Liability and Property Damage Insurance including vehicle coverage issued to the CONTRACTOR and protecting him from all claims for personal injury, including death, and all claims for destruction of or damage to property, arising out of or in connection with any operations under the CONTRACT DOCUMENTS, whether such operations be by himself or by any SUBCONTRACTOR under him, or anyone directly or indirectly employed by the CONTRACTOR or by a SUBCONTRACTOR under him. Insurance shall be written with a limit of liability of not less than, \$500,000 for all damages arising out of bodily injury, including death, at any time resulting therefrom, sustained by any one person in any one accident; and a limit of liability of not less than \$500,000 aggregate for any such damages sustained by two or more persons in any one accident. Insurance shall be written with a limit of liability of not less than \$200,000 for all property damage sustained by any one person in any one accident; and a limit of liability of not less than \$200,000 aggregate for any such damage sustained by two or more persons in any one accident.
- 21.3.2 The CONTRACTOR shall acquire and maintain, if applicable, Fire and Extended Coverage insurance upon the PROJECT to the full insurable value thereof for the benefit of the OWNER, the CONTRACTOR, and SUBCONTRACTORS as their interest may appear. This provision shall in no way release the CONTRACTOR or CONTRACTOR'S surety from obligations under the CONTRACT DOCUMENTS to fully complete the PROJECT.
- 21.4 The CONTRACTOR shall procure and maintain, at his own expense, during the CONTRACT TIME, in accordance with the provisions of the laws of the state in which the work is performed, Workmen's Compensation Insurance, including occupational disease provisions, for all of his employees at the site of the PROJECT and in case any work is sublet, the CONTRACTOR shall require such SUBCONTRACTOR similarly to provide Workmen's Compensation Insurance, including occupational disease provisions for all of the latter's employees unless such employees are covered by the protection afforded by the CONTRACTOR. In case any class of employees engaged in hazardous work under this contract at the site of the PROJECT is not protected under Workmen's Compensation statute, the CONTRACTOR shall provide, and shall cause each SUBCONTRACTOR to provide, adequate and suitable insurance for the protection of his employees not otherwise protected.
- 21.5 The CONTRACTOR shall secure, if applicable, "All Risk" type Builder's Risk Insurance for WORK to be performed. Unless specifically authorized by the OWNER, the amount of such insurance shall not be less than the CONTRACT PRICE totaled in the BID. The policy shall cover not less than the losses due to fire, explosion, hail, lightning, vandalism, malicious mischief, wind, collapse, riot, aircraft, and smoke during the CONTRACT TIME, and until the WORK is accepted by the OWNER. The policy shall name as the insured the CONTRACTOR, the ENGINEER, and the OWNER.

22. CONTRACT SECURITY

- 22.1 The CONTRACTOR shall within ten (10) days after the receipt of the NOTICE OF AWARD furnish the OWNER with a Performance Bond and a Payment Bond in penal sums equal to the amount of the CONTRACT PRICE, conditioned upon the performance by the CONTRACTOR of all undertakings, covenants, terms, conditions and agreements of the CONTRACT DOCUMENTS. and upon the prompt payment by the CONTRACTOR to all persons supplying labor and materials in the prosecution of the WORK provided by the CONTRACT DOCUMENTS. Such BONDS shall be executed by the CONTRACTOR and a corporate bonding company licensed to transact such business in the state in which the WORK is to be performed and named on the current list of "Surety Companies Acceptable on Federal Bonds" as published in the Treasury Department Circular Number 570. The expense of these BONDS shall be borne by the CONTRACTOR. If at any time a surety on any such BOND is declared a bankrupt or loses its right to do business in the state in which the WORK is to be performed or is removed from the list of Surety Companies accepted on Federal BONDS, CONTRACTOR shall within ten (10) days after notice from the OWNER to do so, substitute an acceptable BOND (or BONDS) in such form and sum and signed by such other surety or sureties as may be satisfactory to

the OWNER. The premiums on such BOND shall be paid by the CONTRACTOR. No further payments shall be deemed due nor shall be made until the new surety or sureties shall have furnished an acceptable BOND to the OWNER.

23. ASSIGNMENTS

- 23.1 Neither the CONTRACTOR nor the OWNER shall sell, transfer, assign or otherwise dispose of the Contract or any portion thereof or of his right, title or interest therein, or his obligations thereunder, without written consent of the other party.

24. INDEMNIFICATION

- 24.1 The CONTRACTOR will indemnify and hold harmless the OWNER and the ENGINEER and their agents and employees from and against all claims, damages, losses and expenses including attorney's fees arising out of or resulting from the performance of the WORK. provided that any such claims, damage, loss or expense is attributable to bodily injury sickness, disease or death. or to injury to or destruction of tangible property including the loss of use resulting therefrom; and is caused in whole or in part by any negligent or willful act or omission of the CONTRACTOR, and SUBCONTRACTOR, anyone directly or indirectly employed by any of them or anyone for whose acts any of them may be liable.
- 24.2 In any and all claims against the OWNER or the ENGINEER, or any of their agents or employees, by any employee of the CONTRACTOR, any SUBCONTRACTOR, anyone directly or indirectly employed by any of them, or anyone for whose acts any of them may be liable, the indemnification obligation shall not be limited in any way by any limitation on the amount or type of damages, compensation or benefits payable by or for the CONTRACTOR or any SUBCONTRACTOR under workmen's compensation acts, disability benefit acts or other employee benefits acts.
- 24.3 The obligation of the CONTRACTOR under this paragraph shall not extend to the liability of the ENGINEER, his agents or employees arising out of the preparation or approval of maps, DRAWINGS, opinions, reports, surveys, CHANGE ORDERS, designs or SPECIFICATIONS.

25. SEPARATE CONTRACTS

- 25.1 The OWNER reserves the right to let other contracts in connection with this PROJECT. The CONTRACTOR shall afford other CONTRACTORS reasonable opportunity for the introduction and storage of their materials and the execution of their WORK, and shall properly connect and coordinate his WORK with theirs. If the proper execution or results of any part of the CONTRACTOR'S WORK depends upon the WORK of any other CONTRACTOR, the CONTRACTOR shall inspect and promptly report to the ENGINEER any defects in such WORK that render it unsuitable for such proper execution and results.
- 25.2 The OWNER may perform additional WORK related to the PROJECT by himself, or he may let other contracts containing provisions similar to these. The CONTRACTOR will afford the other CONTRACTORS who are parties to such Contracts (or the OWNER, if he is performing the additional WORK himself), reasonable opportunity for the introduction and storage of materials and equipment and the execution of WORK, and shall properly connect and coordinate his WORK with theirs.
- 25.3 If the performance of additional WORK by other CONTRACTORS or the OWNER is not noted in the CONTRACT DOCUMENTS prior to the execution of the CONTRACT, written notice thereof shall be given to the CONTRACTOR prior to starting any such additional WORK. If the CONTRACTOR believes that the performance of such additional WORK by the OWNER or others involves him in additional expense or entitles him to an extension of the CONTRACT TIME, he may make a claim therefor as provided in Sections 14 and 15.

26. SUBCONTRACTING

- 26.1 The CONTRACTOR may utilize the services of specialty SUBCONTRACTORS on those parts of the WORK which, under normal contracting practices, are performed by specialty SUBCONTRACTORS.
- 26.2 The CONTRACTOR shall not award WORK to SUBCONTRACTOR(s), in excess of fifty (50%) percent of the CONTRACT PRICE, without prior written approval of the OWNER.
- 26.3 The CONTRACTOR shall be fully responsible to the OWNER for the acts and omissions of his SUBCONTRACTORS, and of persons either directly or indirectly employed by them, as he is for the acts and omissions of persons directly employed by him.
- 26.4 The CONTRACTOR shall cause appropriate provisions to be inserted in all subcontracts relative to the WORK to bind SUBCONTRACTORS to the CONTRACTOR by the terms of the CONTRACT DOCUMENTS insofar as applicable to the WORK of SUBCONTRACTORS and to give the CONTRACTOR the same power as regards terminating any subcontract that the OWNER may exercise over the CONTRACTOR under any provision of the CONTRACT DOCUMENTS.
- 26.5 Nothing contained in this CONTRACT shall create any contractual relation between any SUBCONTRACTOR and the OWNER.

27. ENGINEER'S AUTHORITY

- 27.1 The ENGINEER shall act as the OWNER'S representative during the construction period. He shall decide questions which may arise as to quality and acceptability of materials furnished and WORK performed. He shall interpret the intent of the CONTRACT DOCUMENTS in a fair and unbiased manner. The ENGINEER will make visits to the site and determine if the WORK is proceeding in accordance with the CONTRACT DOCUMENTS.
- 27.2 The CONTRACTOR will be held strictly to the intent of the CONTRACT DOCUMENTS in regard to the quality of materials, workmanship and execution of the WORK. Inspections may be made at the factory or fabrication plant of the source of material supply.
- 27.3 The ENGINEER will not be responsible for the construction means, controls, techniques, sequences, procedures, or construction safety.
- 27.4 The ENGINEER shall promptly make decisions relative to interpretation of the CONTRACT DOCUMENTS.

28. LAND AND RIGHTS-OF-WAY

- 28.1 Prior to issuance of NOTICE TO PROCEED, the OWNER shall obtain all land and rights-of-way necessary for carrying out and for the completion of the WORK to be performed pursuant to the CONTRACT DOCUMENTS, unless otherwise mutually agreed.
- 28.2 The OWNER shall provide to the CONTRACTOR information which delineates and describes the lands owned and rights-of-way acquired.
- 28.3 The CONTRACTOR shall provide at his own expense and without liability to the OWNER any additional land and access thereto that the CONTRACTOR may desire for temporary construction facilities, or for storage of materials.

29. GUARANTY

29.1 The CONTRACTOR shall guarantee all materials and equipment furnished and WORK performed for a period of one (1) year from the date of SUBSTANTIAL, COMPLETION. The CONTRACTOR warrants and guarantees for a period of one (1) year from the date of SUBSTANTIAL COMPLETION of the system that the completed system is free from all defects due to faulty materials or workmanship and the CONTRACTOR shall promptly make such corrections as may be necessary by reason of such defects including the repairs of any damage to other parts of the system resulting from such defects. The OWNER will give notice of observed defects with reasonable promptness. In the event that the CONTRACTOR should fail to make such repairs, adjustments, or other WORK that may be made necessary by such defects, the OWNER may do so and charge the CONTRACTOR the cost thereby incurred. The Performance BOND shall remain in full force and effect through the guarantee period.

30. GOVERNING LAW AND DISPUTE RESOLUTION

30.1 This Agreement will be governed by the laws of the State of Alabama.

30.2 The parties agree that all disputes between them shall first be submitted to mediation. All disputes, controversies or claims shall be subject to mediation as a condition precedent to the institution of legal or equitable proceedings by either party. Request for mediation shall be filed in writing with the other party to this Agreement and with the American Arbitration Association. The request may be made concurrently with the filing of legal or equitable proceedings, which shall be stayed pending mediation for a period of 60 days from the date of filing, unless stayed for a longer period by agreement of the parties or court order. The parties shall share the mediator's fee and any filing fees equally. The mediation shall be held at the Reservation of the Poarch Band of Creek Indians, unless another location is mutually agreed upon. Agreements reached in mediation shall be enforceable as settlement agreements in any court having jurisdiction thereof.

30.3 If the dispute cannot be so resolved, either Party may bring an action in a court of competent jurisdiction located in the first instance in the United States District Court for the Southern District of Alabama, and if, and only if, such court does not accept jurisdiction, then in the Circuit Court of Coffee County, Alabama.

30.4 The CONTRACTOR will carry on the WORK and maintain the progress schedule during any mediation or litigation, unless otherwise mutually agreed in writing.

31. TAXES

31.1 The CONTRACTOR will pay all sales, consumer, use and other similar taxes required by the law of the place where the WORK is performed.

SUPPLEMENTAL GENERAL CONDITIONS

1. INSURANCE

- 1.1 The Contractor shall provide umbrella form general liability coverage with a limit of liability of not less than \$1,000,000 which applies to general and automobile liability coverage.

2. PROTECTION OF OWNER

- 2.1 The Contractor hereby agrees to hold harmless, indemnify and defend the Owner, the Owner's agent, the Consulting Engineer, and the Owner's employees while acting within the scope of their duties from and against any and all liability, claims, damages, and cost of defense arising out of the Contractor's performance of the work described herein but not including the sole negligence of the Owner, his agents or employees. The Contractor will require any and all subcontractors to conform with the provisions of this clause prior to commencing any work. **The Contractor shall furnish an Owner's Protective Liability Policy which lists both the Owner and the Engineer as Named Insured.** This insurance coverage shall be provided in a policy separate from the Contractor's insurance policies, and a copy of the policy shall be provided to the Engineer. The limits of liability shall be not less than \$1,000,000.

3. ADVERTISEMENT OF CLOSING

- 3.1 The Contractor shall attach to the final payment estimate an affidavit of publication (with clipping) from a newspaper of general circulation in the county where work was done, that completion has been advertised weekly for four consecutive weeks. First notice must be subsequent to completion. Employ the following copy:

“Notice is hereby given that (contractor and address) has completed all work on the **STREET IMPROVEMENTS – ANGEL STREET, PARKER STREET, VINE STREET, BRYANT STREET, & 4TH AVENUE (FROM CEDAR STREET TO THE TOWN LIMITS)** in **Beatrice, Alabama.**” All persons having any claim for labor, materials, or otherwise in connection with this project should immediately notify the above named contractor and the Town Clerk of the Town of Beatrice.

4. SUBCONTRACTING

- 4.1 The Contractor shall not award work to subcontractor(s) in excess of fifty (50%) percent of the contract price, without prior written approval of the Owner.

5. **TIME FOR COMPLETION AND LIQUIDATED DAMAGES**

ARTICLE 15 of the GENERAL CONDITIONS is hereby revised to read as follows:

- 5.1 It is hereby understood and mutually agreed, by and between the Contractor and the Owner, that the date of beginning and the time for completion as specified in the contract of the work to be done hereunder are ESSENTIAL CONDITIONS of this Contract; and it is further mutually understood and agreed that the work embraced in this Contract shall be commenced on a date to be specified in the "Notice to Proceed."
- 5.2 The Contractor agrees that said work shall be prosecuted regularly, diligently and uninterruptedly at such rate of progress as will insure full completion thereof within the time specified. It is expressly understood and agreed, by and between the Contractor and the Owner, that the time for the completion of the work described herein is a reasonable time for the completion of the same, taking into consideration the average climatic range and usual industrial conditions prevailing in this locality.
- 5.3 If the said Contractor shall neglect, fail or refuse to complete the work within the time herein specified, or any proper extension thereof granted by the Owner, then the Contractor does hereby agree, as a part consideration for the awarding of this Contract, to pay to the Owner the amount specified in the Contract, not as a penalty but as liquidated damages for such breach of contract as hereinafter set forth, for each and every calendar day that the Contractor shall be in default after the time stipulated in the Contract for completing the work.
- 5.4 The said amount is fixed and agreed upon by and between the Contractor and the Owner because of the impracticability and extreme difficulty of fixing and ascertaining the actual damages the Owner would in such event sustain, and said amount is agreed to be the amount of damages which the Owner would sustain and said amount shall be retained from time to time by the Owner from current periodical estimates.
- 5.5 It is further agreed that time is of the essence of each and every portion of this Contract and the specifications wherein a definite and certain length of time is fixed for the performance of any act whatsoever; and where under the Contract an additional time is allowed for the completion of any work, the new time limit fixed by such extension shall be of the essence of this Contract. Provided, that the Contractor shall not be charged with liquidated damages or any excess cost when the Owner determines that the Contractor is without fault and the Contractor's reasons for the time extension are acceptable to the Owner; provided, further, that the Contractor shall not be charged with liquidated damages or any excess cost when the delay in completion of the work is due:
- 5.5.1 To any preference, priority or allocation order duly issued by the Government.
- 5.5.2 To unforeseeable cause beyond the control and without the fault or negligence of the Contractor, including, but not restricted to, acts of God, or of the public enemy, acts of the Owner, acts of another Contractor in the performance of a contract with

the Owner, fires, floods, epidemics, quarantine restrictions, strikes, freight embargoes and severe weather.

5.5.3 To any delays of Subcontractors or suppliers occasioned by any of the causes specified in subsections (a) and (b) of this article.

5.6 Provided, further, that the Contractor shall, within ten (10) days from the beginning of such delay, unless the Owner shall grant a further period of time prior to the date of final settlement of the Contract, notify the Owner, in writing, of the causes of the delay, who shall ascertain the facts and extent of the delay and notify the contractor within a reasonable time of its decision in the matter.

6. **PAYMENTS TO CONTRACTOR**

Portions of ARTICLE 19 of the GENERAL CONDITIONS are revised to read as follows:

6.1 The OWNER shall retain five (5) percent of the amount of each payment until the project is fifty (50) percent complete after which no further retainage shall be withheld. The retainage stated above shall be held by the OWNER until final completion and acceptance of the work, and meet all conditions of the Contract.

6.2 Prior to final payment, a NONRESIDENT CONTRACTOR shall satisfy the OWNER that he or she has paid all taxes due and payable to the State of Alabama or any political subdivision thereof. For the purpose of this Article, a NONRESIDENT CONTRACTOR is one who is neither (a). organized and existing under the laws of the State of Alabama, nor (b). maintains its principal place of business in the State of Alabama. A NONRESIDENT CONTRACTOR which has maintained a permanent branch office within the State of Alabama for at least five continuous years shall no thereafter be deemed to be NONRESIDENT CONTRACTOR so long as the Contractor continues to maintain a branch office within Alabama.

6.3 Final Payment shall be made to the Contractor no less than 10 days following receipt by the Owner of:

1. A properly executed, and duly certified payment estimate.
2. A release of all claims filed against the Contractor, or claims of lien filed against the Owner, arising under or by virtue of the Contract or completed work.
3. A proof of advertisement of project completion. However, the final payment shall not be made until the expiration of thirty days after completion of the advertisement.
4. For NONRESIDENT CONTRACTORS, proof of payment of all taxes due the State of Alabama, or any political subdivision thereof.

6.4 Only those portions of ARTICLE 19 of the GENERAL CONDITIONS which conflict with the Articles above are revised. All other portions of Article 19 shall remain as stated in the GENERAL CONDITIONS.

7. **CONTRACT SECURITY**

- 7.1 ARTICLE 22 of the GENERAL CONDITIONS of the Contract are revised such that the amount of the PAYMENT BOND will not exceed 50% of the Contract Price.

8. **ASSIGNMENT**

- 8.1 ARTICLE 23 of the GENERAL CONDITIONS is hereby revised to include the following:

Under no circumstances shall a contract be assigned to an unsuccessful bidder whose bid was rejected because he or she was not a responsive bidder.

9. **DOMESTIC PRODUCTS AND STEEL**

- 9.1 The Contractor to whom the Construction Contract is awarded shall use materials, supplies, and products manufactured, mined, processed, or otherwise produced in the United States or its territories, if the same are available at reasonable and competitive prices, and are not contrary to any sole source specification included in the Contract.

- 9.2 The Contractor shall use steel produced within the United States when the specifications require the use of steel, and do not limit its supply to a sole source.

- 9.3 The Contractor shall provide the Owner a certification that only domestic products and steel will be used in the completion of the work subsequent to the contract. The Certification shall be provided prior to the execution of the contract, and shall be executed by the same person who executes the Contract on behalf of the Contractor, and shall be notarized. The Contractor shall also provide copies of similar certifications from material and equipment suppliers as a part of any submittals presented to the Engineer for approval.

- 9.4 In the event the Contractor violates the agreement to use domestic or steel, and domestic products or steel are not used, there shall be a downward adjustment in the contract price equal to any realized savings or benefits to the Contractor.

10. **COMPLIANCE WITH PL 91-596 AND PL 91-54**

- 10.1 The Contractor shall comply with the Department of Labor Safety and Health Regulations for construction promulgated under the Occupational Safety and Health Act of 1970 (PL 91-596) and under section 107 of the Contract Work Hours and Safety Standards Act (PL 91-54).

11. EXPERIENCE CLAUSE

- 11.1 The general use of experience clauses requiring equipment manufacturers to have a record of satisfactory operation for a specific period of time or bonds or deposits to guarantee replacement in the event of failure is restricted to special cases where the grantee's engineer adequately justifies any such requirement in writing. Where such justification has been made, submission of a bond or deposit shall be permitted in lieu of a specified experience period, and the period of time for which such bond or deposit is required should not exceed the period specified.

**SPECIAL SPECIFICATIONS
FOR
PAVING IMPROVEMENTS
ANGEL STREET, PARKER STREET, VINE STREET, BRYANT STREET, & 4TH AVENUE (FROM CEDAR
STREET TO THE TOWN LIMITS)
FOR
BEATRICE, ALABAMA**

1. GENERAL

- 1.1 The work to be done under this Contract consists of resurfacing four (4) streets with bituminous asphalt wearing surface and overlaying 4th Avenue (from Cedar Street to the Town Limits) with bituminous asphalt wearing surface and bituminous asphalt upper binder, and other related items, in the Town of Beatrice as shown on the Plans.
- 1.2 The price bid for the items in the Proposal are intended to provide full compensation to the Contractor for completing all items of work necessary to complete the improvements described in the Project Plans and Specifications. When no bid item is provided for work described by the Plans or these Specifications, the work shall be considered incidental to the project and the cost shall be included in other items of work provided in the Proposal.
- 1.3 Any major items which may have been omitted which are found by the proposed bidders shall be called to the attention of the Engineer prior to the bid so that an Addendum can be issued.
- 1.4 Any work under this Contract not specifically covered by the Plans or these Specifications shall comply with the applicable sections of the Alabama Department of Transportation Standard Specifications for Highway Construction (ALDOTSSHC), Latest Edition.
- 1.5 The Owner reserves the right to add to or delete portions of the paving, resurfacing, or other items from this project to match the funds available.
- 1.6 The Owner will retain all asphalt millings that are acquired during the planing process. The millings will be delivered to a location designated by the Owner.

2. CLIPPING SHOULDERS

- 2.1 The Contractor shall clean the edges of the streets as necessary to remove grass and dirt from the existing surface and to establish a clean edge along the existing curb. All paving surfaces shall be thoroughly broomed and cleaned as necessary to remove all loose material, dirt, grass, and debris from the existing surface.

2.2 Payment for **Clipping Shoulders** shall be paid as a subsidiary obligation of all other Pay Items and shall be full compensation for all labor, equipment, and materials necessary to complete this work to the satisfaction of the Owner and Engineer.

3. TRAFFIC CONTROL

3.1 The Contractor shall be solely responsible for traffic control and signs during the project. A minimum of one-way traffic shall be maintained at all times and access to all businesses and residences shall be provided at all times. The Contractor shall comply with the applicable provisions of the Federal Manual on Uniform Traffic Control Devices, including Part VI of the manual, in handling traffic during construction, and for providing temporary traffic control measures. He shall also comply with applicable portions of Section 740 of the Alabama Department of Transportation Standard Specifications for Highway Construction (ALDOTSSHC), Latest Edition.

3.2 During construction, the Contractor shall communicate with the Police Chief to maintain coordination with the City and with its emergency services. The Contractor shall conduct his work in such a way that he does not obstruct or delay any type of emergency service which may need to be provided within the City.

3.3 The Engineer, in performance of his duties outlined in these Specifications, does not guarantee or ensure the Contractor's compliance with these regulations. Payment for **Traffic Control** shall be on a lump sum basis.

4. MOBILIZATION

4.1 Included in the Proposal is a pay item to cover all cost related to mobilizing, obtaining permits, license, bonds and insurance for this project. The contractor shall include in the amount bid for this item all costs related to providing bonds, insurance, and other security as required by ALDOT, County Highway Department, or City for work to be performed under this contract. Any additional cost related to this item shall be included in the other various bid items.

5. BITUMINOUS CONCRETE, LEVELING SURFACE

5.1 Leveling of the existing roadway may be required as directed by the Engineer. The plant mix material shall be installed in accordance with Section 410 and Section 424, of the ALDOTSSHC, Latest Edition. Payment for all leveling will be paid for at the contract unit price bid for **Bituminous Concrete Leveling**, per ton. **Tack Coat** shall be applied per ALDOTSSHC, Latest Edition.

6. BITUMINOUS CONCRETE, WEARING SURFACE

- 6.1 A layer of 424A-340 Superpave Bituminous Concrete Wearing Surface shall be constructed on the roads, streets, and intersections as shown on the plans. The Contractor shall also pave a minimum of a three (3) foot apron at each intersection adjacent to the streets being resurfaced. Before the wearing layer is placed, the underlying layer shall receive a bituminous tack coat to be applied in accordance with Section 405 of the ALDOTSSHC, Latest Edition. The wearing layer shall have a maximum thickness of 1.5". The wearing layer shall be constructed with a ½" maximum aggregate size in accordance with Section 410 and Section 424 of the ALDOTSSHC, Latest Edition. Payment for the wearing layer shall be at the Contract unit price for **Bituminous Concrete Wearing Surface**, per ton in place.
- 6.2 The quantity of **Bituminous Concrete Wearing Surface** placed as directed by the Engineer will be measured in tons of 2,000 pounds. Payment will be made on tonnage basis and the contract unit price per ton shall be full compensation for construction of the bituminous wearing surface complete in place on the roadbed as directed, including all materials, procurement, handling, hauling, and processing cost, and includes all equipment, tools, labor, and incidentals required to complete the work. **Tack Coat** and **Joint Sealant** shall be applied per ALDOTSSHC, Latest Edition.

7. BITUMINOUS CONCRETE, PATCHING

- 7.1 The Contractor shall repair all streets, roads, highways, drives, parking lots, or other pavement damaged during construction, whether on public or private property. The Contractor shall also repair any potholes and/or existing utility cuts that have settled over time.
- 7.2 The Contractor shall backfill all streets in accordance with the Technical Specifications and shall compact this backfill to the following densities in accordance with the AASHTO T 99 Specification for the Standard Proctor Density Test:
 - 1. Base material and top six inches of backfill: 100%
 - 2. Remainder of backfill: 98%
- 7.3 The pavement replacement shall consist of a 6-inch thickness of compacted sand clay or clay gravel base material, a Type A prime coat, a 1.5-inch layer of Bituminous Concrete Binder Layer, and 1.5-inch layer of Bituminous Concrete Wearing Surface. All pavement replacement work shall be in accordance with the Alabama Department of Transportation Standard Specification for Highway Construction (ALDOTSSHC), Latest edition. The existing pavement shall be sawed or cut to provide a uniform edge to tie the new paving to the existing pavement. The paving is to be replaced to a width of 6-inches beyond the limits of the trench such that 6-inches of the paving patch is resting on undisturbed material. The edge of the existing paving shall be thoroughly tacked to provide a bond between the new and old paving. Wearing Surface will be paid separately. All other items necessary for

completion of Patching shall be for as **Bituminous Concrete, Patching** on a tonnage basis. **Tack Coat** shall be applied per ALDOTSSHC, Latest Edition.

- 7.4 In order to minimize the damage to the existing paved streets, a method of compliance shall be utilized for trench protection on storm drainage piping that is installed in the street paving which minimizes the width of paving to be cut, e.g. trench box or shoring. All cost associated with providing trench protection shall be included in the various items bid in the proposal. No additional payment will be made for providing trench protection if required.

8. BITUMINOUS CONCRETE, UPPER BINDER

- 8.1 The plant mix material shall be installed in accordance with Section 410 and Section 424, of the ALDOTSSHC, Latest Edition. Payment for all Upper Binder will be paid for at the contract unit price bid for **Bituminous Concrete, Upper Binder**, per ton. **Prime Coat** shall be applied per ALDOTSSHC, Latest Edition.

9. TRAFFIC CONTROL MARKINGS

- 9.1 The Contractor shall apply traffic control markings where they currently exist and as directed by the Engineer. All materials and application methods shall comply with Section 703 of the Alabama Department of Transportation Standard Specifications for Highway Construction (ALDOTSSHC), Latest Edition. Accepted traffic control markings shall be paid under the proposal item for **Traffic Control Markings, Class 2, Type A**, per square foot.

10. Roadbed Processing (4th Avenue)

- 10.1 Roadbed construction shall comply with the applicable requirements of Section 230 of the ALDOT standard specifications, "Roadbed Processing," for a modified roadbed. Payment for the roadbed processing shall be at the Contract unit price for **Roadbed Processing**, per roadbed station.

11. Prime Coat (4th Avenue)

- 11.1 Contractor is to coordinate with Engineer and City personnel to determine suitability of existing surface for placement of Asphalt paving. Existing on site material is comprised of soil and gravel. Site conditions may require clipping, minor grading, etc. to ensure an acceptable finished asphalt surface with positive drainage. A Prime Coat shall be placed in accordance with Section 401 of the ALDOTSSHC. Payment is to be made on a gallon basis for **Prime Coat (4th Avenue)** and shall include all required materials, equipment, and labor. No additional payment will be made.

12. DRIVEWAYS

- 12.1 Where existing asphalt, dirt, or gravel driveways exist, the Contractor shall pave a one (1) foot apron in each driveway adjacent to the streets being resurfaced or paved. This apron shall match the grade of the driveway and shall be placed such that water does not pond in the driveway. The apron shall facilitate drainage by preventing street water from entering the driveway, or conveying driveway water into the street as appropriate. The cost of these aprons shall be included in the price bid for Bituminous Concrete Wearing Surface, per ton in place.

Where existing concrete drives and concrete sidewalks exist, the Contractor shall pave to the existing edge of concrete. No removal of concrete in these areas are required, regardless of the condition of the existing concrete.

13. DENSITY AND TESTING REQUIREMENTS

- 13.1 At the request of the Engineer, the Contractor shall provide the necessary equipment and personnel to cut samples from the compacted pavement for testing. Samples not smaller than four inches square or four inches in diameter for the full depth of the course to be tested shall be taken at the locations directed by the Engineer. Furnishing of suitable, approved cutting equipment, the cutting of the samples, and the immediate repair of the sample holes with similar type material shall be performed by the Contractor without extra compensation. The cost of all soils, concrete and asphalt field and laboratory testing deemed necessary by the Engineer, other than the design mixes (which are required), will be paid for by the **Materials Testing** cash allowance item included in the Proposal. The amount of this cash allowance will be adjusted to reflect the actual cost of this testing work and all testing shall be performed by the Engineer or the Engineer's subcontractor(s). The Contractor will provide assistance to the materials testing personnel in obtaining the necessary samples of soil and asphalt.
- 13.2 At least two copies of all test results will be furnished to the Contractor as soon as they are available. Any areas found by the testing to be deficient in any way will be retested after the deficiency is corrected by the Contractor, unless otherwise directed by the Engineer.
- 13.3 The Contractor shall submit a mix design for the bituminous concrete wearing surface that has been approved by the State. This mix design shall be submitted to and be approved by the Engineer prior to placing any asphalt on the job.
- 13.4 The Engineer or his authorized representative will select locations for all tests to be conducted. A cash allowance has been set up in the Proposal to cover the cost of all testing. The Engineer will provide invoices to the Contractor for the costs of all **Materials Testing** (up to the amount of the cash allowance) and the Contractor shall include such cost in his monthly payment requests.

14. LICENSE AND PERMITS

14.1 The Contractor shall be responsible for the purchase of all licenses and permits required by the City, County, State or Federal government, and shall comply with all laws, ordinances, or regulations of those governments in pursuance of the work spelled out in this contract. The Contractor shall purchase a Contractor's License from the Town of Beatrice for this work, and he shall be responsible for determining the cost of this license.

15. ACCIDENT PREVENTION, SAFETY, AND PROTECTION OF PROPERTY

15.1 The Contractor will be responsible for initiating, maintaining, and supervising all safety precautions and programs in connection with the work. The Owner will require that caution shall be exercised by the Contractor at all times for the protection of persons (including employees) and property and he shall comply with the safety provisions of all applicable laws and building codes. The Contractor shall comply with all applicable OSHA criteria and shall maintain a safety program as outlined in the Manual of Accident Prevention in Construction published by the Associated General Contractors of America.

15.2 The Contractor alone shall be liable for any claims or lawsuits made or filed in connection with damages, injuries, loss of life or other accidents caused by his construction operations or due to his negligence or to the negligence of his employees in taking proper and adequate precautions to insure the safety of the general public, his own employees, or any other person or property, or due to unforeseen accidents incident to the work such as trench cave-ins, ruptured utility lines and conduits, etc. The Contractor shall indemnify and save harmless the Owner, the Owner's engineer, and all other agents, officials, or employees of the Owner, against any claims or lawsuits made or filed against him in connection with his work under this contract.

15.3 Prior to beginning construction work, the Contractor shall thoroughly document the condition of all existing landscaping, structures, and other improvements which may be affected by his operations. **The manner in which documentation is accomplished shall be acceptable to the Engineer but as a minimum, shall include a color video(s) of the construction area with audio describing the area and tying the location to the project location.** A complete set of documentation will be available on the job site to help determine what restoration work is required to return any disturbed property to its original condition and to settle disputes concerning the original conditions of any property.

15.4 By executing this Contract, the Contractor admits he has a full understanding of all provisions and ramifications of this chapter of the Contract and commits to fulfill all his obligations outlined in it.

16. TIME FOR COMPLETION, LIQUIDATED DAMAGES, & WORK SCHEDULE

- 16.1 The Contractor must commence work on or before a date to be specified in a written "Notice to Proceed" issued by the Owner and must fully complete the project within thirty (30) consecutive calendar days thereafter. For each calendar day thereafter, the Contractor shall be subject to a charge of \$500.00 per day as liquidated damages.
- 16.2 The Contractor shall notify the Engineer at least 48 hours prior to performing any work in order that arrangements can be made for a construction observer to be on site during the construction.
- 16.3 The time for completion of this Contract is based on a standard weekly work schedule of Monday through Friday. No work shall be scheduled or performed on Saturday, Sunday, or holidays, except for any required emergency maintenance work, without the prior approval of the Engineer.

17. SUBCONTRACTING

- 17.1 The Contractor shall not subcontract more than 50% of the contract work without written permission of the Owner. The Owner shall approve all subcontractors. Prior to beginning any work on the contract, the Contractor shall submit a list of all subcontractors along with a description of the work planned for each subcontractor; a list of previous projects completed; a list of references; a list of the subcontractor's equipment to be used on the project; a list of credit references; and a copy of the proposed contract between the prime contractor and subcontractor.
- 17.2 No subcontractor will be approved for work on this Contract who cannot demonstrate ability to satisfactorily complete the work.

18. EQUIPMENT AND MATERIAL

- 18.1 All equipment and material selections shall be submitted to the Engineer for approval prior to the purchase of the equipment and materials.

19. EXISTING UTILITIES AND UNDERGROUND OBSTRUCTIONS

- 19.1 In excavating and backfilling care must be taken not to remove, disturb or injure any water, sewer, gas, electric, telephone, or other conduits or utilities encountered without prior approval of the Owner of the utility, including private utilities. If necessary, in order to perform the intended work, the Contractor shall sling, shore up, and maintain such utilities in operation, and promptly repair any damage done to them. Before final acceptance of the work, all such utilities shall be made "equal or better" than prior to construction.
- 19.2 It shall be the Contractor's responsibility to give sufficient prior information to the utility owner that construction will take place whereby the utility owner will be afforded an opportunity to adequately mark, on the ground or with sufficient maps, the utility locations. Coordination of such information and utility locations shall be the sole responsibility of the Contractor. In event of damage to the utilities, the Contractor will promptly notify the utility

owner (private or public) and must assume full responsibility thereof. Failure of the Contractor to promptly notify the utility owner shall make him liable for any needless loss or interference with normal operations of the utility.

- 19.3 In the event that pipes or conduits providing service to adjoining buildings are broken, or damaged to some questionable degree of service, the Contractor shall immediately make repairs at his own expense or be otherwise liable for repair costs incurred by others. Delays which would result in service being off overnight or needlessly for long periods during the day will not be tolerated. The utility owner reserves the right to make repairs, to utilities or structures damaged by the Contractor, without prior notice. Removal or relocation of a utility encountered may be done upon prior approval by the utility owner give directly to the Contractor.
- 19.4 Prior to construction and/or bidding, the Contractor shall satisfy himself as status of the underground obstructions by making direct contact with utility firms, if he so desires, to become thoroughly aware of true conditions. The utility lines shown on the plans and any notes on the plans pertaining to underground obstructions were taken from those records available for the system, and there was no intent to show the details and locations of all underground obstructions which may be encountered. The information shown is for the Contractor's convenience only, and it shall not be used as a basis for claims for extra compensation.

20. CLEAN-UP

- 20.1 Throughout the progress of the work, the Contractor shall keep the construction area, including storage areas used by him, free from accumulations of waste material or rubbish. Disposal of all waste materials shall be the responsibility of the Contractor and shall be at locations satisfactory to the Engineer.

21. MISCELLANEOUS

- 21.1 The Contractor shall abide by all local and state laws or ordinances to the extent that such requirements do not conflict with federal laws or regulations.
- 21.2 It is the intent of this Contract to provide a complete resurfacing and striping job for the unit prices bid for the various items of work included in the Proposal. The cost of the miscellaneous work required to complete the job including but not limited to clipping the street edges, brooming, clipping the asphalt high spots, etc., is to be included in the unit prices bid for various items in the Proposal.
- 21.3 All Contractors shall note the requirements of Paragraphs 4, 11, and 12 of the Supplemental General Conditions concerning insurance requirements for this work.
- 21.4 No work shall be initiated on this project until the Contractor has all equipment on the job that is required to clean up and properly maintain the site.



SOUTHERN

ENGINEERING SOLUTIONS

PERSONAL SERVICE...PROFESSIONAL SOLUTIONS

201 EAST TROY ST
P.O. BOX 610
ANDALUSIA, AL 36420

OFFICE 334.222.1849
FAX 334.222.1869
SOUTHERNENGINEERINGSOLUTIONS.COM

PAVING IMPROVEMENTS

Angel Street, Parker Street, Vine Street, Bryant Street, & 4th Avenue (From Cedar Street To The Town Limits)

BEATRICE, ALABAMA

July, 2020

MAYOR
ANNIE M. SHELTON

CITY CLERK
ALYSSA HOUSE

CITY COUNCIL
SATISHA HUDSON
MAX WATSON
LYNDA SPANN
MAGGIE SPENCER
MARSHALL MONTGOMERY

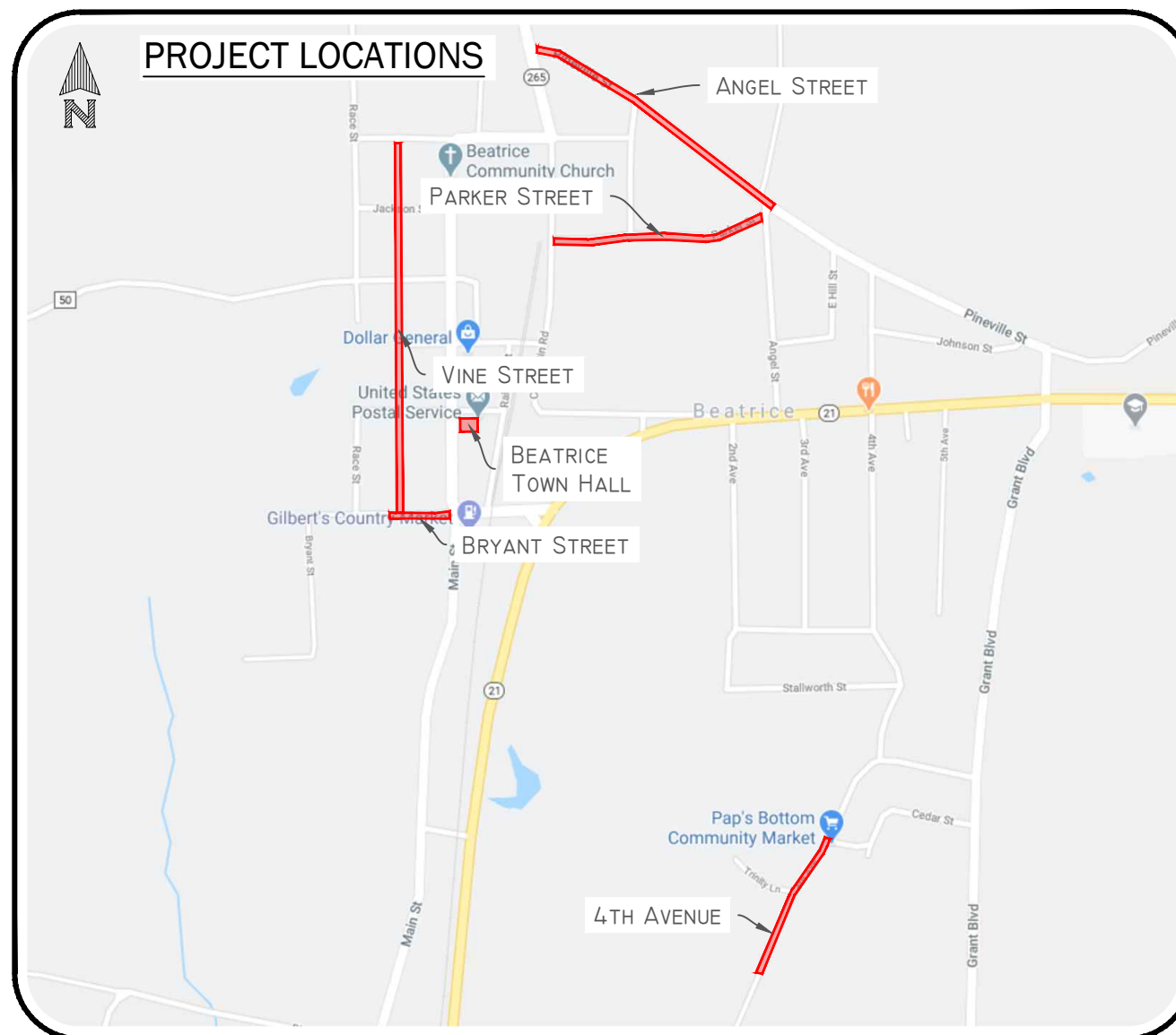

Drawing Index	
1	Title Sheet
2	Vicinity Map
3	Angel Street Paving Plan Layout
4	Angel Street/Bryant Street Paving Plan Layout
5	Parker Street Paving Plan Layout
6-7	Vine Street Paving Plan Layout
8	4th Avenue Paving Plan Layout
9	Project Details
10	Traffic Control Plan



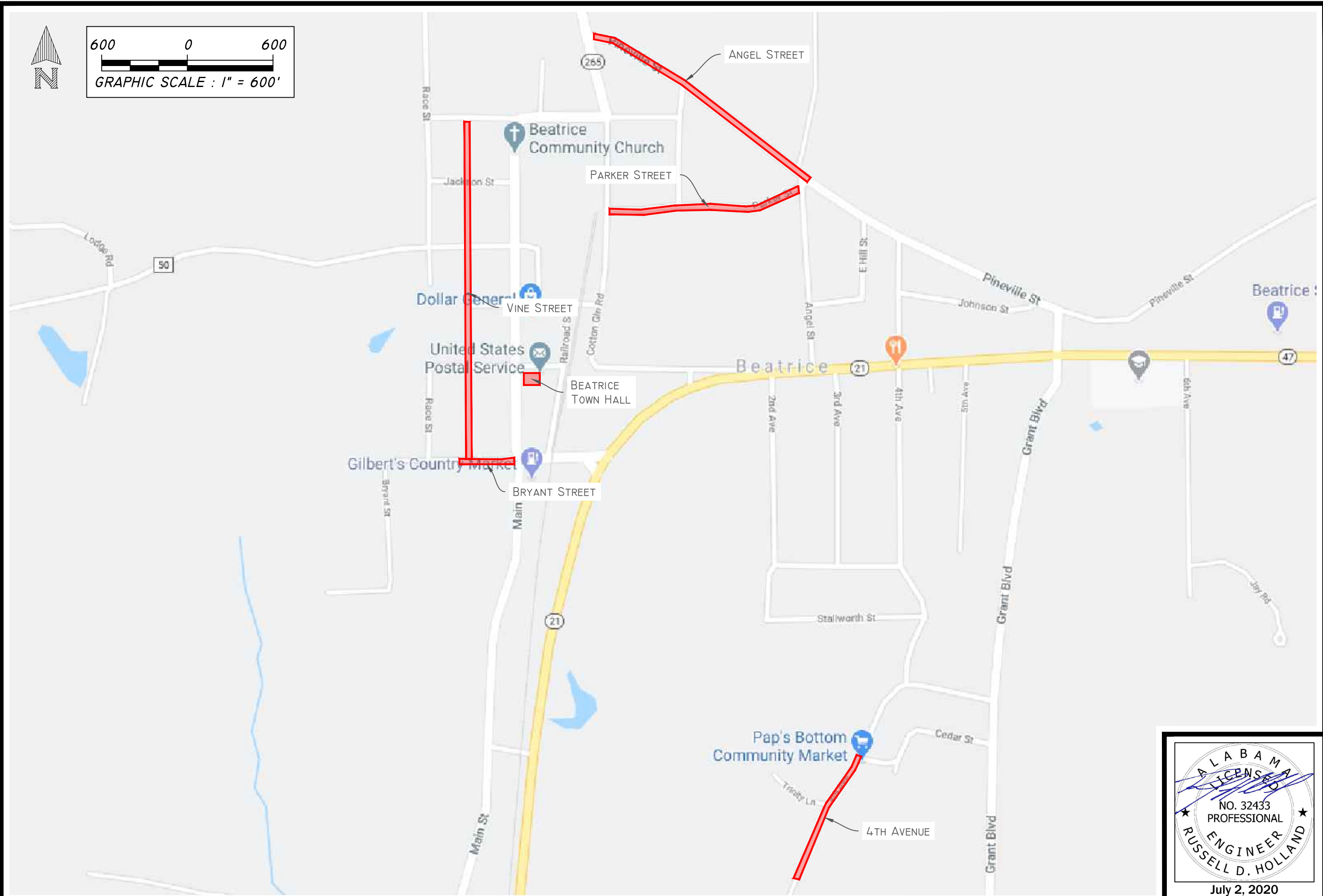
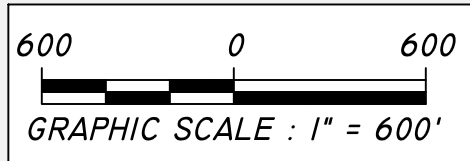

Vicinity Map
Beatrice Paving Improvements
Beatrice, Alabama

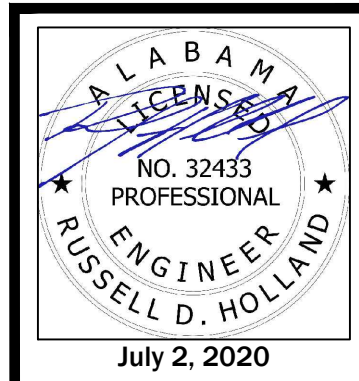

DESIGNED BY	RDH
DRAWN BY	JAC
DATE	July, 2020
CADD FILE	*
PROJECT NO	2018501
REVISED	*
SHEET	2 OF 10

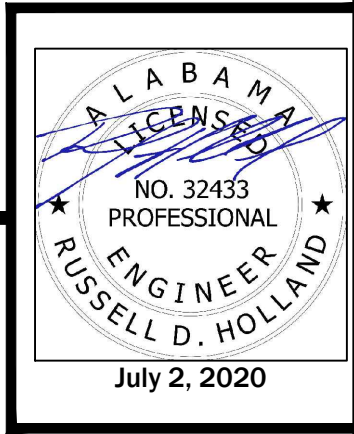
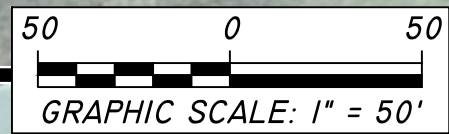

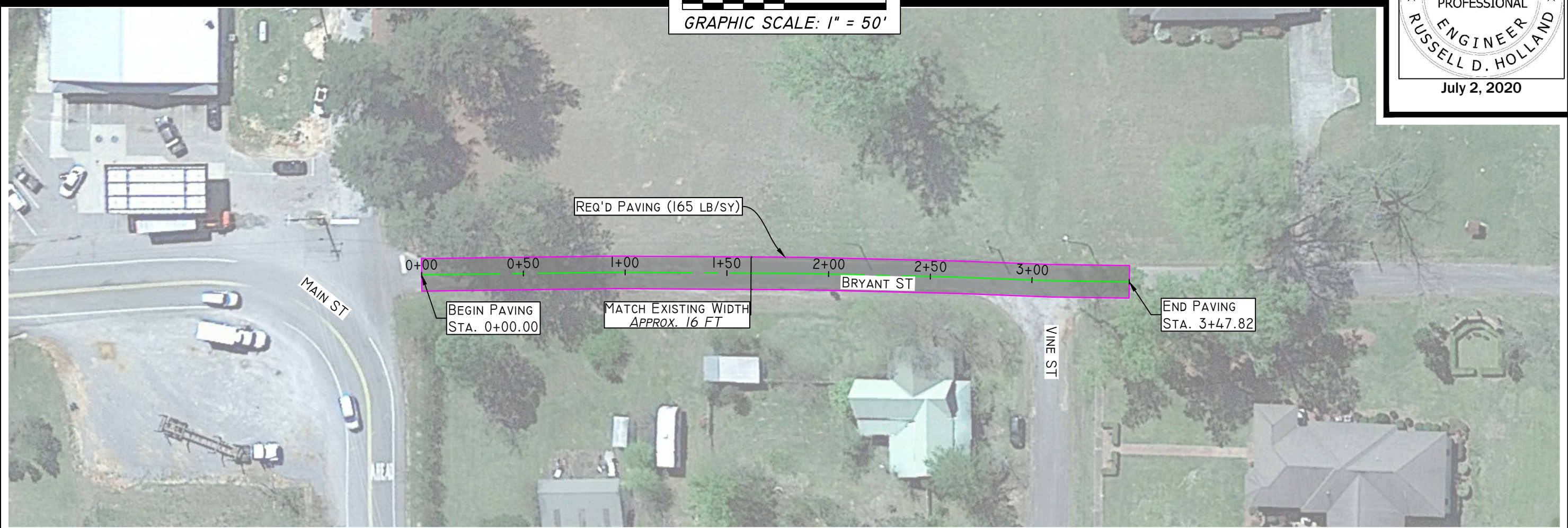
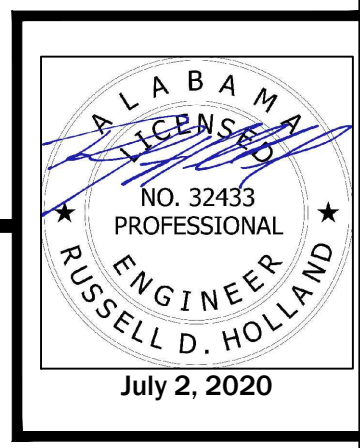
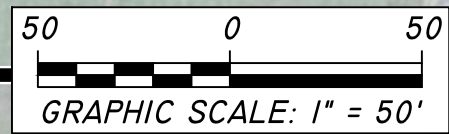
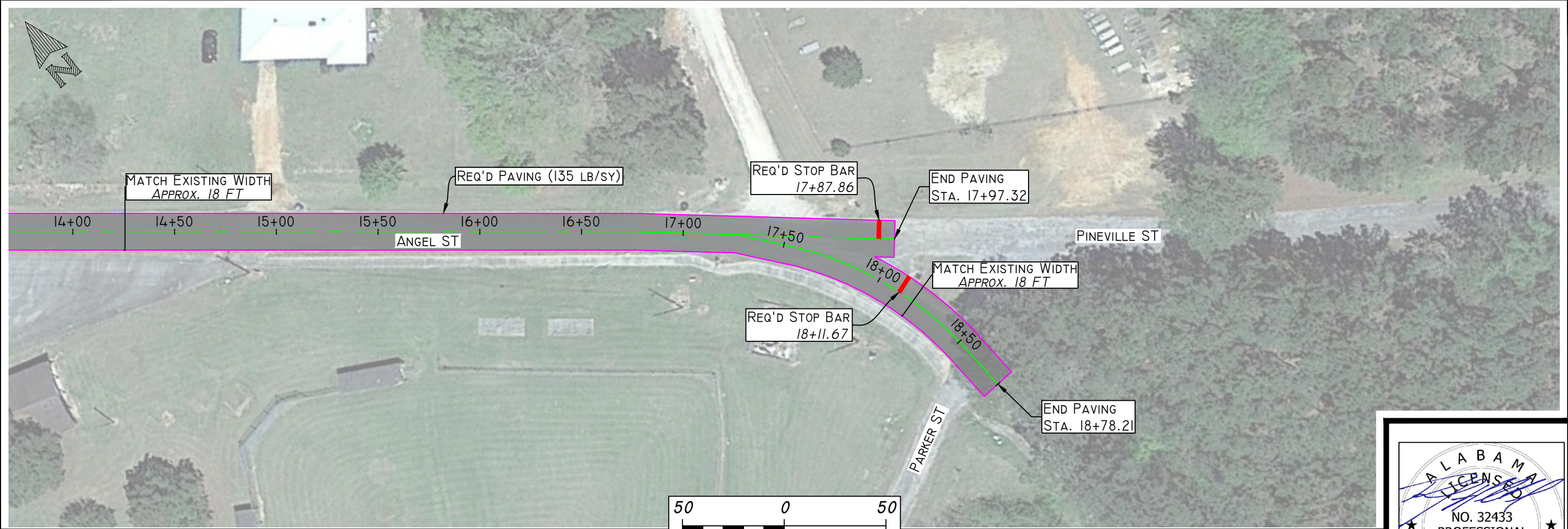

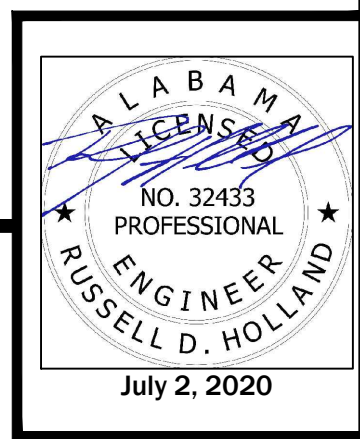
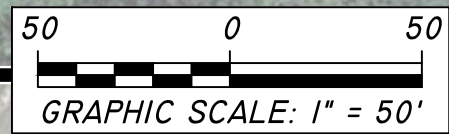

DESIGNED BY	RDH
DRAWN BY	JAC
DATE	July, 2020
CADD FILE	*
PROJECT NO	2018501
REVISED	*
SHEET	5 OF 10

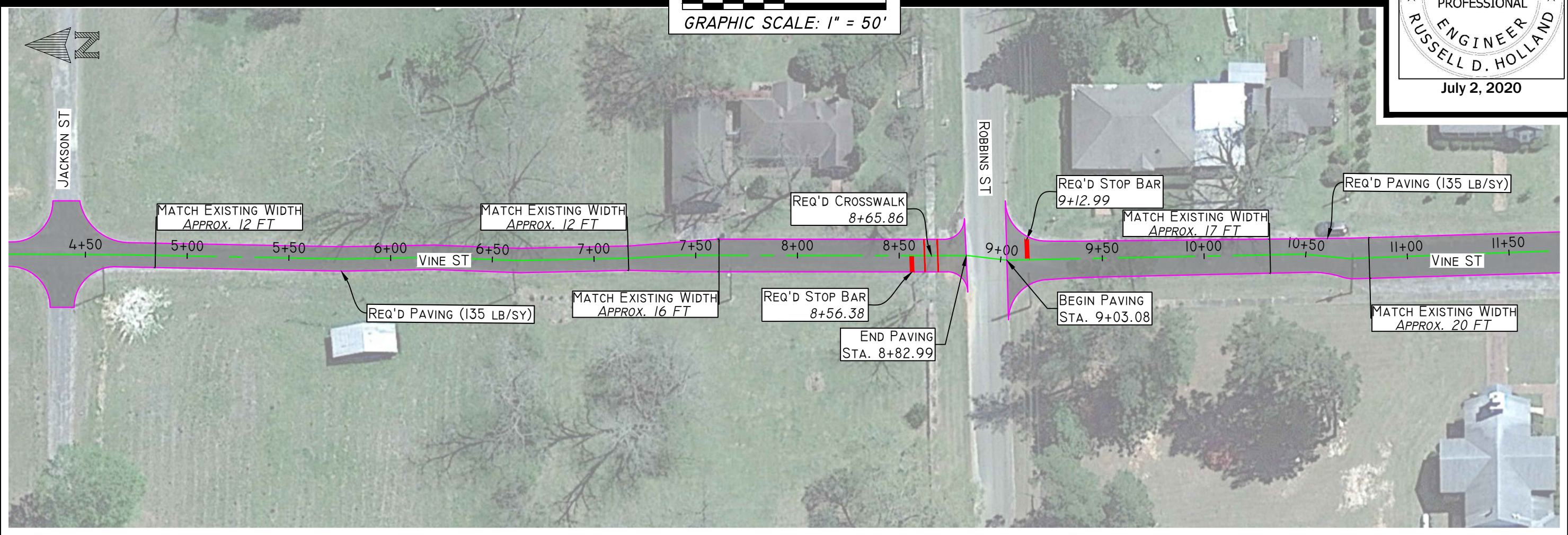
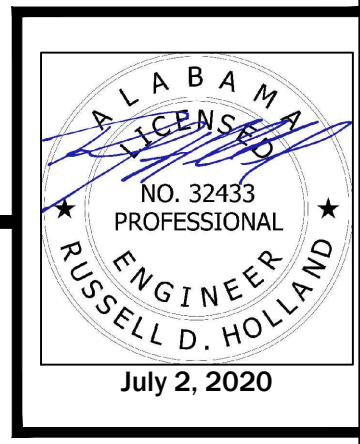
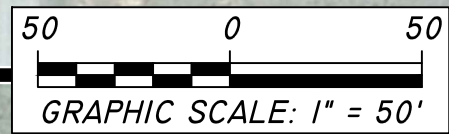

DESIGNED BY	RDH
DRAWN BY	JAC
DATE	July, 2020
CADD FILE	*
PROJECT NO	2018501
REVISED	*
SHEET	6 OF 10

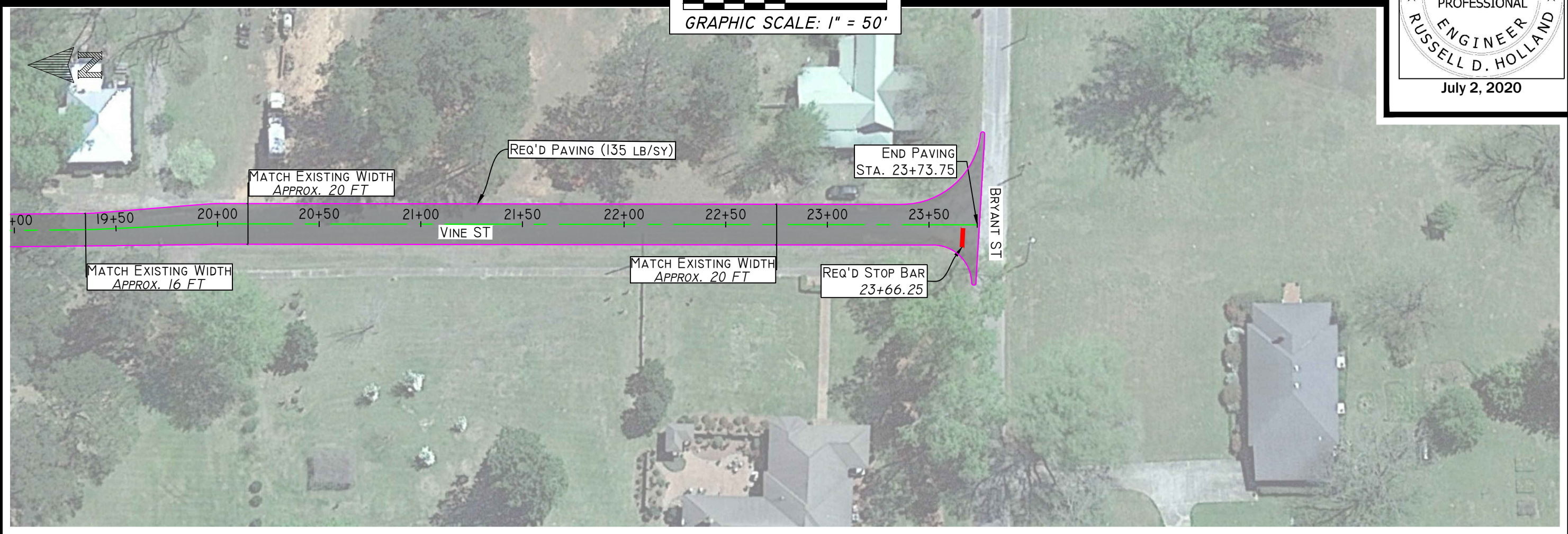
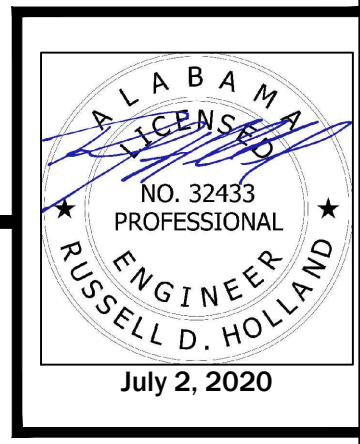
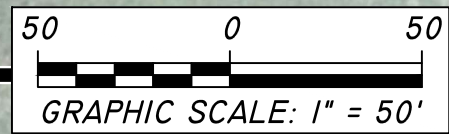

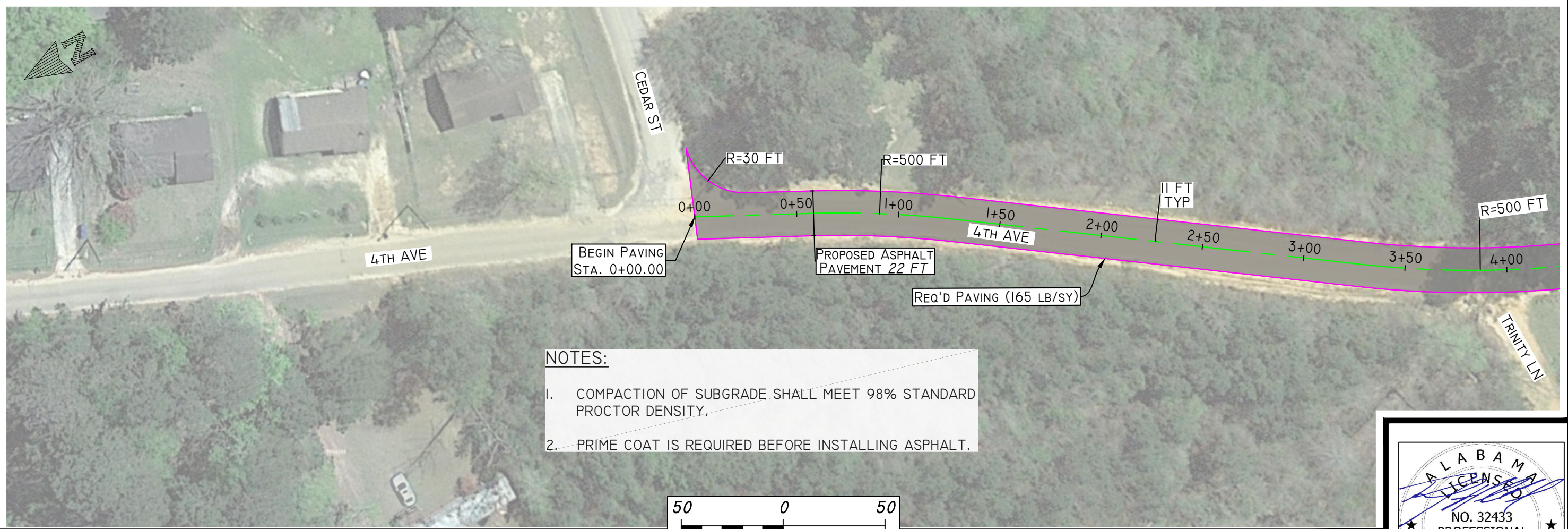

- NOTES:**
1. COMPACTION OF SUBGRADE SHALL MEET 98% STANDARD PROCTOR DENSITY.
 2. PRIME COAT IS REQUIRED BEFORE INSTALLING ASPHALT.

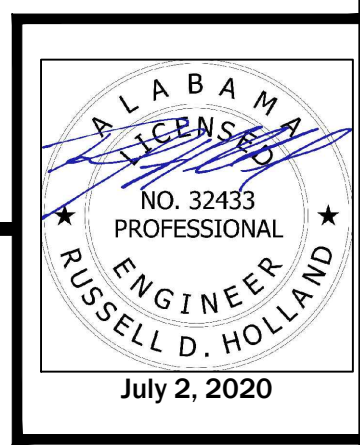
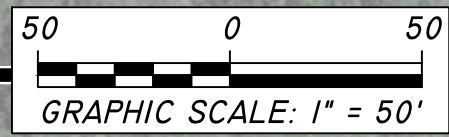

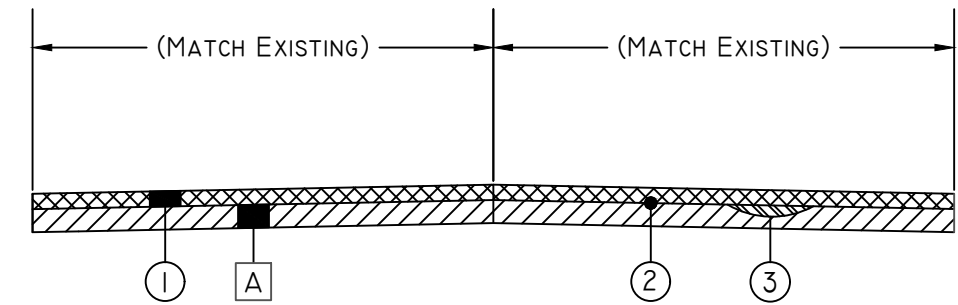
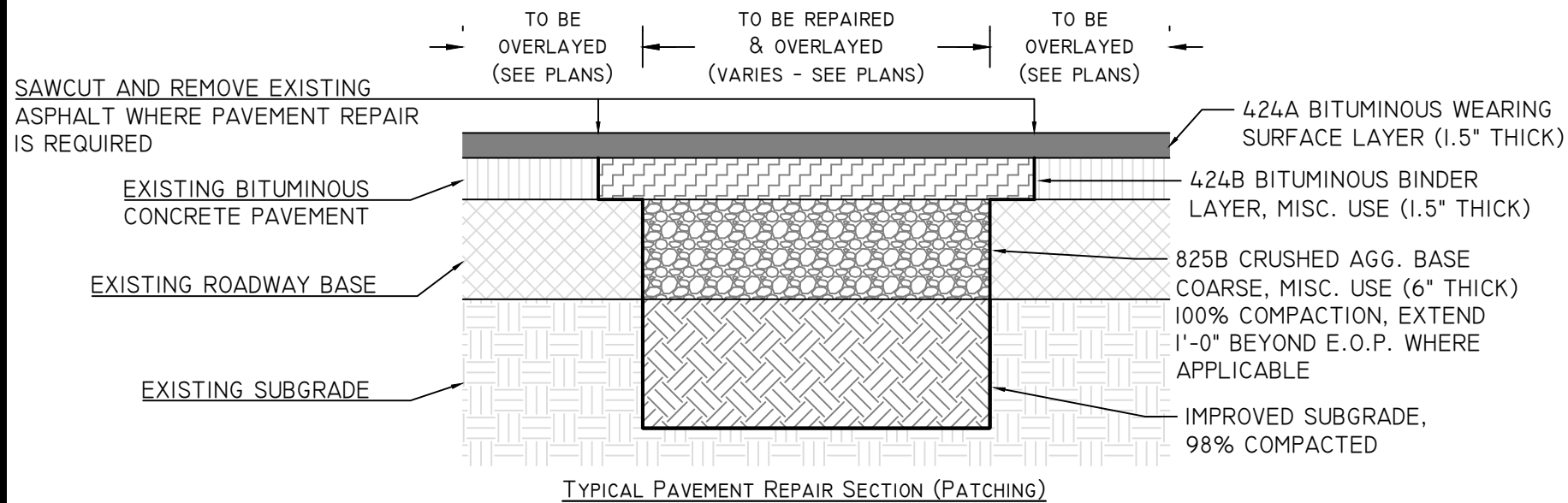

TYPICAL SECTION

DESCRIPTION

- ①- SUPERPAVE BITUMINOUS CONCRETE WEARING SURFACE LAYER, 1/2" MAXIMUM AGGREGATE SIZE MIX, ESAL RANGE A/B (165 LB/SY)
- ②- TACK COAT (PAID AS SUBSIDIARY TO WEARING SURFACE)
- ③- SUPERPAVE BITUMINOUS UPPER BINDER LAYER, LEVELING, 1/2" MAXIMUM AGGREGATE SIZE MIX, ESAL RANGE A/B
- A- EXISTING BITUMINOUS ASPHALT PAVEMENT

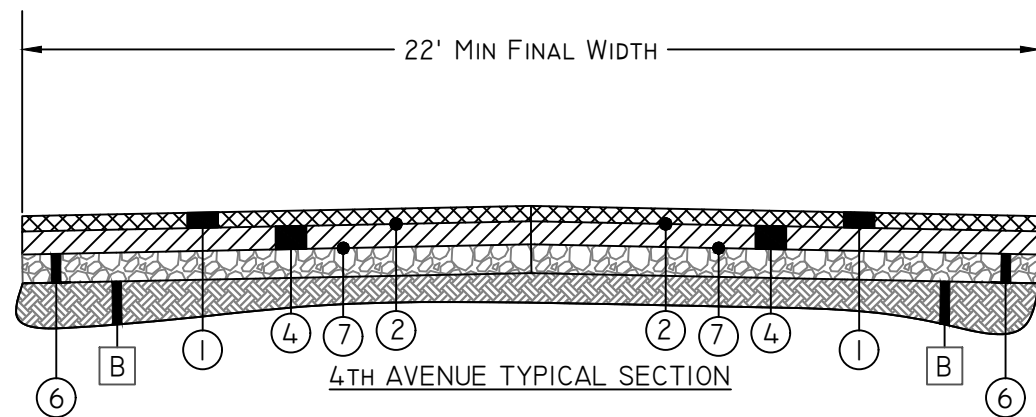

DESCRIPTION

- ①- SUPERPAVE BITUMINOUS CONCRETE WEARING SURFACE LAYER, 1/2" MAXIMUM AGGREGATE SIZE MIX, ESAL RANGE A/B (165 LB/SY)
- ②- TACK COAT (PAID AS SUBSIDIARY TO WEARING SURFACE)
- ④- REQ'D 424B-648 SUPERPAVE BITUMINOUS CONCRETE BINDER LAYER, 1-1/2 IN MAXIMUM AGGREGATE SIZE MIX, ESAL RANGE A/B (APPROX. 165 LB/SY)
- ⑥- CRUSHED AGGREGATE BASE COURSE, 825 B, 6" COMPACTED THICKNESS (OR APPROVED EQUAL), COMPACTED TO 100% OF AASHTO T-180 SPECS
- ⑦- PRIME COAT
- B- EXISTING SUB-BASE TO BE COMPACTED TO 98% OF AASHTO T-99 SPECS

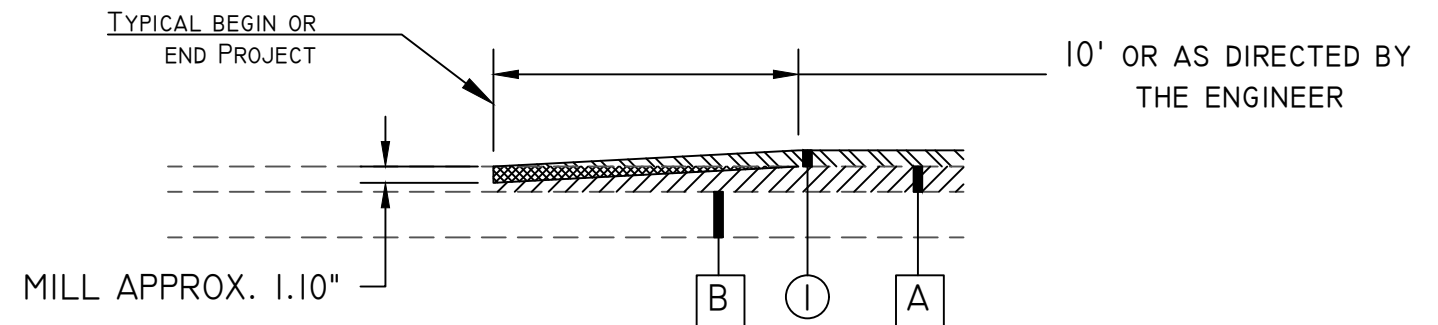

TYPICAL BEGIN/END PROJECT IN OVERLAY SECTIONS

NOT TO SCALE

LEGEND

- ①- SUPERPAVE BITUMINOUS CONCRETE WEARING SURFACE LAYER, 1/2" MAXIMUM AGGREGATE SIZE MIX, ESAL RANGE A/B (165 LB/SY)
- A- EXISTING BITUMINOUS ASPHALT PAVEMENT
- B- EXISTING SUB-BASE TO BE COMPACTED TO 98% OF AASHTO T-99 SPECS

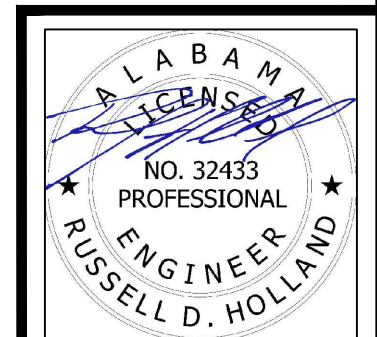

July 2, 2020

END ROAD WORK G20-2A
 (PLACE 500 FT. PAST THE WORK LIMITS SHOWN ON THE TITLE SHEET)

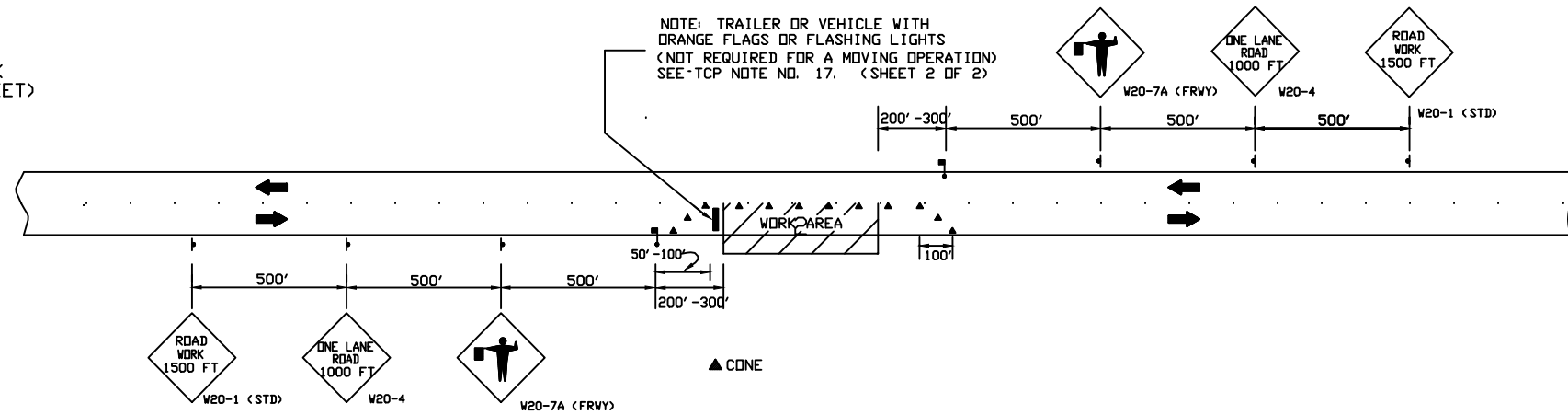

ROAD WORK NEXT XX MILES G20-1
 (PLACE IN ADVANCE OF THE WORK LIMITS SHOWN ON THE TITLE SHEET)

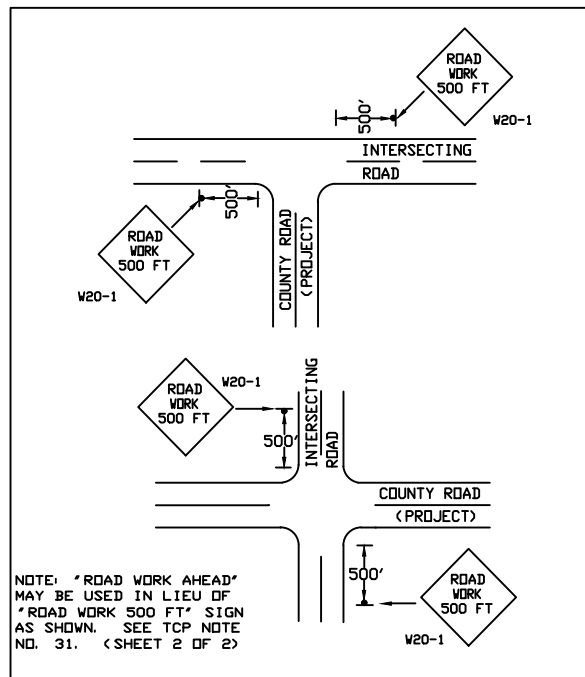
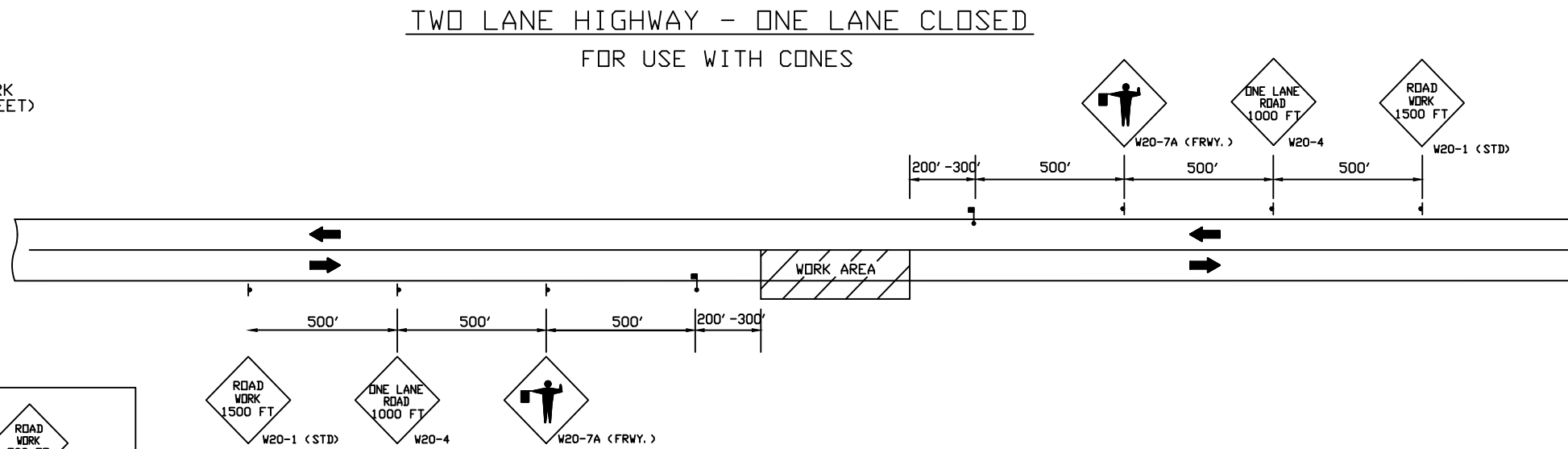

DETAIL FOR PLACEMENT OF W20-1 SIGN AT INTERSECTING ROADS

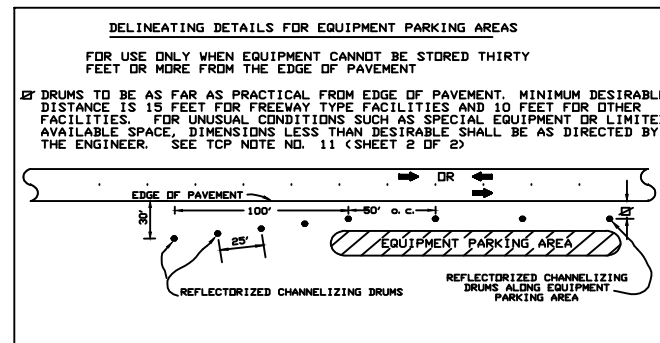

DELINEATING DETAILS FOR EQUIPMENT PARKING AREAS

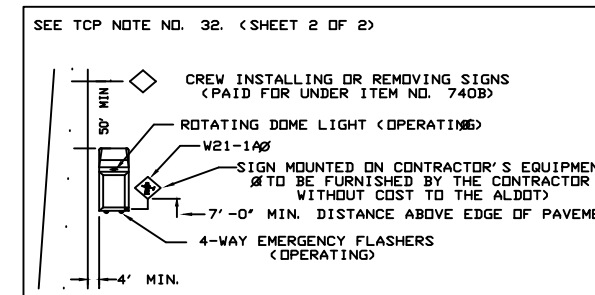

T. C. P. FOR INSTALLING OR REMOVING CONSTRUCTION SIGNS

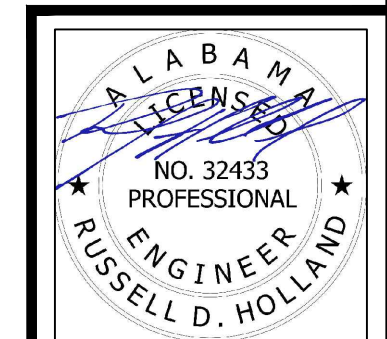

July 2, 2020